

**Fighting Fire
With Fire** *page 15*



**Wildland
Fire Edition**



NATURAL

VOLUME 4, NUMBER 1 • USDA FOREST SERVICE

INQUIRER

Dew It!

page 47



**Let's Clear
the Air** *page 6*



**Smoke
and
Mirrors**

page 34



**Liar! Liar!
House on Fire!**

page 41

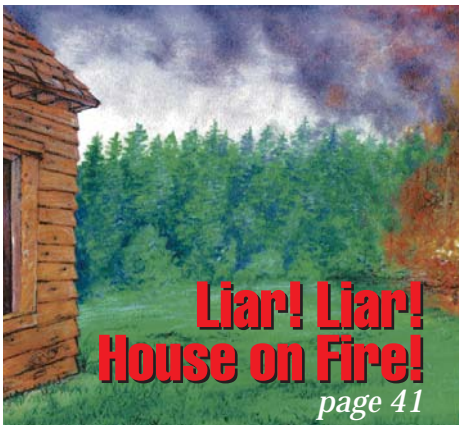

**Time Will
Tell**

page 21



**Who
Gives
a Hoot?**

page 27

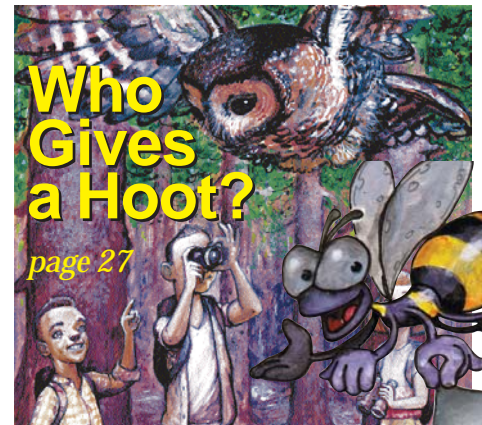

The Natural Inquirer

Volume 4, No. 1, Spring 2003

Wildland Fire Edition

Barbara McDonald
USDA Forest Service
Research and Development
Washington Office

Jean Szymanski
USDA Forest Service
Southwestern Region
Albuquerque, NM

*USDA Forest Service
scientists highlighted in the
journal:*

Ron Babbitt
Jan Beyers
Jack Cohen
Paulette Ford
Armando González-Cabán
Wei Min Hao
Roger Ottmar
Brian Potter
Ron Susott
Dale Wade

*Other scientists
highlighted in the journal:*

Isaac Bertschi
Dave Griffith
John Loomis
Tim Reinhardt
Darold Ward
Bill Wirtz
Bob Yokelson

Produced by:
USDA Forest Service
Dale Bosworth, Chief

Research and Development,
Washington, DC
Robert Lewis, Deputy Chief
Resource Valuation and Use
Research Staff

State and Private Forestry
Joel Holtrop, Deputy Chief
Conservation Education Staff
Denver James, Acting
Director

With thanks to:
Kathleen Cullinan,
Ag in the Classroom
USDA Cooperative State
Research, Education, and
Extension Service
Washington, DC

John Owens
National Interagency Fire
Center and Bureau of Land
Management
Boise, ID
Katrina Krause
USDA Forest Service
Athens, GA
Jessica Tanner
Atlanta City Public Schools
Atlanta, GA
Firewise Communities
Program
Quincy, MA
Fire and Aviation
Management
USDA Forest Service
Washington, DC
Office of Communication
USDA Forest Service
Washington, DC
USDA Design Center
Washington, DC
USDA Forest Service
Southern Research Station
Athens, GA

This *Natural Inquirer* issue is
dedicated to the memory of
Eugene P. Odum, a great
ecologist and educator.

The U.S. Department of
Agriculture (USDA) prohibits dis-
crimination in all its programs and
activities on the basis of race, color,
national origin, sex, religion, age,
disability, political beliefs, sexual
orientation, and marital or family
status. (Not all prohibited bases
apply to all programs.) Persons
with disabilities who require alter-
native means for communication of
program information (Braille, large

print, audiotope, etc.) should con-
tact USDA's TARGET Center at
(202) 720-2600 (voice and TDD).

To file a complaint of discrimi-
nation, write USDA, Director,
Office of Civil Rights, Room 326-
W, Whitten Building, 1400
Independence Avenue, SW,
Washington, DC 20250-9410 or
call (202) 720-5964 (voice and
TDD). USDA is an equal opportu-
nity provider and employer.



United States Department of Agriculture



Forest Service

FS-692

Editorial Review Board

Members of Ms. Jessica
Tanner's 5th grade
science class
Mary Lin
Elementary School
Atlanta City Public Schools
Atlanta, GA

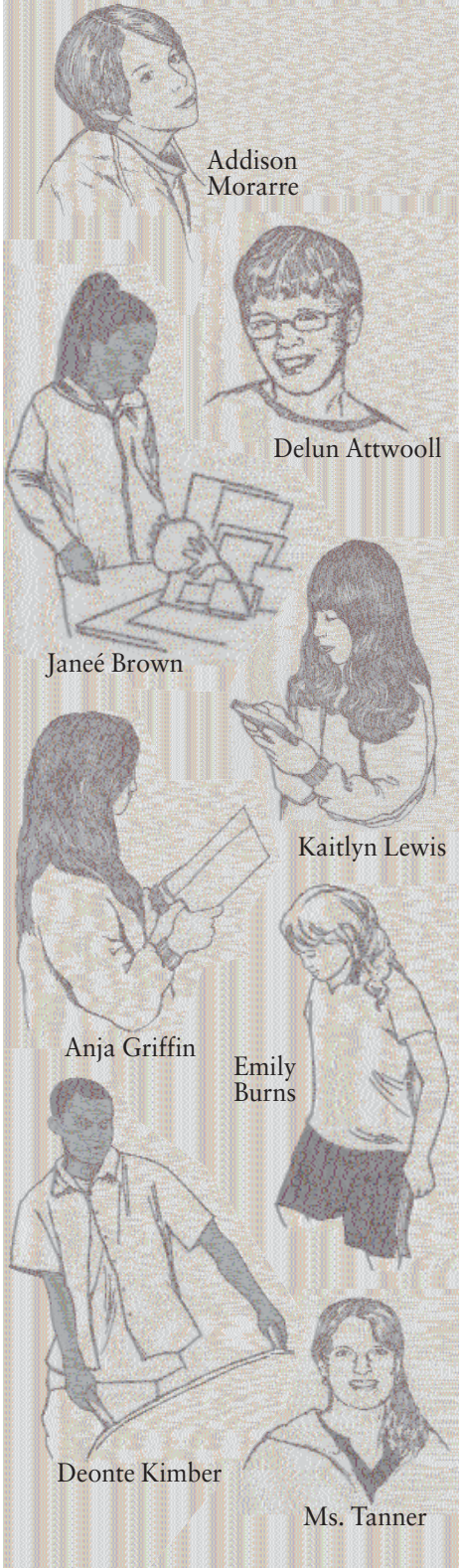

Addison
Morarre

Delun Attwooll

Janeé Brown

Kaitlyn Lewis

Anja Griffin

Emily
Burns

Deonte Kimber

Ms. Tanner

Contents

Teacher's Note2
 About the *Natural Inquirer*3
 What Are Scientists?3
 Welcome to the *Natural Inquirer*
 Wildland Fire Edition!5

Features

Let's Clear the Air:

The Danger of Forest Fire Smoke to Firefighters6

Fighting Fire With Fire:

Protecting the Homes of People and Birds15

Time Will Tell:

Does Wildfire Damage the Prairie?21

Who Gives a Hoot?

Determining the Value of Owl Habitat27

Smoke and Mirrors:

Detecting the Amount of Gases in
Wildland Fire Smoke34

Liar! Liar! House on Fire!

The Relationship Between Trees, Wildland Fire,
and Damage to Homes41

Dew It!

Which Weather Measurements Are Related
to the Occurrence of Wildland Fire?47

Student Evaluation Form52

Teacher Evaluation Form53

Website Connections55

Which National Science Education Standards

Can Be Addressed by the Natural Inquirer56

What Is the USDA Forest Service?Back Cover

What Is Agriculture in the Classroom?Back Cover

What Is the National Interagency Fire Center? Back Cover

The *Natural Inquirer* is reproduced on recycled paper with soy-based inks.
Please pass this journal along or recycle it when you have finished using it!

Teacher's Note

As teachers of science, you want your students to acquire abilities that will enable them to conduct scientific inquiry, and you want them to gain an understanding of the scientific inquiry process. Scientific inquiry can best be taught by integrating minds-on and hands-on experiences. Over time, such experiences encourage students to independently formulate and seek answers to questions about the world we live in. As educators, you are constantly faced with engaging your students in scientific inquiry in new and different ways. In an age of abundant technology, standard teaching strategies can become monotonous to today's learners. The *Natural Inquirer* provides a fresh approach to science and a view of the outside world bigger than the classroom that can be used while still in the school setting.

The *Natural Inquirer* is a science education resource journal to be used with learners from Grade 5 and up. The

Natural Inquirer contains articles describing environmental and natural resource research conducted by USDA Forest Service scientists and their cooperators. These are scientific journal articles that have been reformatted to meet the needs of middle school and higher students. The articles are easy to understand, are aesthetically pleasing to the eye, contain glossaries, and include hands-on activities. The goal of the *Natural Inquirer* is to stimulate critical reading and thinking about scientific inquiry and investigation while learning about ecology, the natural environment, and natural resources.

Science Education Standards and Evaluations:

In the back of the journal, you will find a matrix that allows you to identify articles by the national science education standards that they address. You will also find evaluation forms in the back of the journal. Please make copies of these evaluation forms and have your students complete them after they complete an article. Please note the form for teachers to complete

also. Please send the evaluation forms to the address listed at the end of the forms. You and your students may also complete the forms online by visiting www.naturalinquirer.usda.gov.

This journal was created by Conservation Education Research and Development, an education program of the USDA Forest Service. If you have any questions or comments, please contact:

Dr. Barbara McDonald
USDA Forest Service
320 Green St.
Athens, GA 30602-2044
706.559.4224
barmac@bigfoot.com

Teacher's Manual:

To read the teacher's manual online, download it, or request a hard copy, visit the *Natural Inquirer* Web site at www.naturalinquirer.usda.gov.

At this Web site, you will also find previous issues of the *Natural Inquirer*, sample lesson plans, word games, the teacher's manual, information about the USDA Forest Service, and other resources.

Visit www.naturalinquirer.usda.gov for previous issues of the *Natural Inquirer*, sample lesson plans, word games, the teacher's manual, information about the USDA Forest Service, and other resources.

About the Natural Inquirer

Scientists report their research in journals, which are special booklets that enable scientists to share information with one another. This journal, the *Natural Inquirer*, was created so that scientists can share their research with you and other middle school students. Each article tells you about scientific research conducted by scientists in the USDA Forest Service. If you want to know more about the USDA Forest Service, you can read about it on the back cover of this journal, or you can visit the *Natural Inquirer* Web site at www.naturalinquirer.usda.gov.

All of the research in this *Natural Inquirer* is concerned with wildland fires. In each arti-

cle, you will “meet the scientist” who conducted the research. Then you will read something special about science and about the natural environment. You will also read about a specific research project. This is written in the format that scientists use when they publish their research in journals. Then, YOU will become the scientist when you conduct the FACTivity associated with each article. Don’t forget to look at the glossary and the special sections highlighted in each article. These sections give you extra information about wildland fire.

At the end of each section of the article, you will find a few questions to help you think about what you have read. These questions are not a test! They should help you to think more about the research. Your teacher may use these questions in a class discussion.

What Are Scientists?

Scientists are people who collect and evaluate information about a wide range of topics. Some scientists study the natural environment. To be a successful environmental scientist, you must:

- **Be curious** — You must be interested in learning.
- **Be enthusiastic** — You must be interested in an environmental topic.
- **Be careful** — You must be accurate in everything that you do.
- **Be open minded** — You must be willing to listen to new ideas.

- **Question everything** — You must think about what you read and observe.

Scientists in this issue at work.



Welcome to the Wildland Fire Edition of the Natural Inquirer !

Wildland fires have been in the news a lot. Every year, it seems, we hear about more frequent and more severe wildland fires. Wildland fires are fires that burn in forests, on prairies, or over other large natural areas. Wildland fires may start naturally or they may be started by human activity. Wildfires are large, uncontrolled wildland fires that usually burn large areas of land. They are typically started by lightning or by a careless human act.

In the past, we thought that most wildland fires were bad, and we tried to stop these fires from burning. We now know that wildland fire is neither good or bad, it is simply a natural part of the environment. Many plants need occasional fire to reproduce, and fire offers other benefits to the natural environment. For example, when fire burns

decaying branches and stumps, the nutrients from the plants are released into the soil, making them available to new plants. Without fire, open environments such as prairies eventually become covered with trees. When fires are not allowed to burn occasionally in the wildlands, the thick growth of plants near the ground level provides a lot of potential fuel. If a wildfire then begins to burn, it burns hotter and faster because of the extra fuel. Thus, by trying to eliminate wildland fire in the past, we have actually enabled larger fires to burn. To keep this from happening, land managers can start small, controlled fires that burn the fuel that is close to the ground. These fires are called managed fires or prescribed fires.

This edition of the *Natural Inquirer* is all about wildland fire. You will learn about the

benefits of wildland fire, as well as some of its dangers. You will learn what fire scientists are learning about wildland fire. They are learning, for example, that wildland fire should not be completely eliminated from natural environments, but it should be managed. They are learning how to predict which weather conditions most favor a wildfire being started. They are learning about the relationship between wildland fires and global warming. They are learning how to best protect homes and other buildings from wildfires. And they are learning about how wildland fires can benefit the natural environment.

Even though wildland fire can be beneficial to the environment, it is always dangerous. As you have always heard, you should never play with matches or with fire. If you see an uncontrolled fire burning, no matter where it is, immediately get away from the fire, and report the fire to an adult. Never leave a campfire unattended, and make certain that it is completely put out before you leave it. Wildland fires are interesting, and they are fun to learn about. As you will see when you read the articles, all of the scientists in this journal enjoy learning about wildland fire. We hope that you enjoy learning about it too!

Is Your Community Firewise?

No forested community is completely safe from wildfire, but we can be wise about how our homes and communities are designed and built. A Firewise home and community is one that is designed, built, and maintained to withstand a wildfire without the help of the fire department. To help people create Firewise

homes and communities, the Firewise Communities program was created. This program teaches people that live in forested communities how to keep their homes safe from wildfires. You can read some of their tips on page 46 of this journal, and you can visit www.firewise.org for more information.



Let's Clear the Air:

The Danger of Forest Fire Smoke to Firefighters

Meet Mr. Reinhardt:

I like being a scientist because I get to solve hard problems for people. I also learn more about what is true, rather than what is thought to be true.



Meet Mr. Ottmar:

I like being a scientist because I can provide new knowledge and develop tools to help *forest managers* to become better *stewards* of the land.



Thinking About Science

Science can be classified into two very broad categories. These categories

are called basic science and applied science. When a scientist conducts basic science, he or she is working on answering a question that adds to our knowledge but may not directly help to solve an immediate problem. *Astronomers*, for example, are scientists that conduct basic science. In the USDA Forest Service, most of the research conducted is in the applied science category. When a scientist conducts applied science, he or she is trying to solve an immediate problem. In this study, the scientists wanted to measure some of the health risks from fighting wildland fires. They also wanted to find an easy way for firefighters to determine those risks. In applied science, the results of research can be applied to an immediate problem.

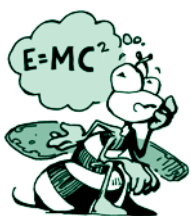

Glossary:

forest managers (f^{ör} est man ij ^{ürs}): Skilled individuals that take care of natural resources.

stewards (stoo ^{ürds}): People that take care of large areas of land.

astronomers (uh staw no ^{mürs}): Scientists that study the stars, planets, comets, etc.

fire managers (fir man uh ^{jürs}): People whose job it is to prevent or control wildland fires.

data (da tuh): Facts or figures studied in order to make a conclusion.

sample (sam pul): A part or piece that shows what the whole group or thing is like.

analyze (an uh liz): To separate something into its parts in order to examine them.

average (av rij): The number determined by dividing the sum of two or more quantities by the number of quantities added.

scale (skal): A series of marks along a line, with regular spaces in between, used for measuring.

relationship (re la shun ship): When two or more things are connected in some fashion.

Pronunciation Guide

a	as in ape	ô	as in for
ä	as in car	u	as in use
e	as in me	ü	as in fur
i	as in ice	oo	as in tool
o	as in go	ng	as in sing

Accented syllables are in bold.

Thinking About the Environment

The natural environment provides humans and other animals with what we need to live. This includes, for example, air, water, and a temperature that is neither too hot nor too

cold. Sometimes, however, parts of the natural environment can become dangerous for humans and other living things. The danger can be natural, as when a volcano or flood occurs, or can be caused by human activity. When humans pollute the air, for example, the air might be dangerous to breathe. In this study, the scientists studied the danger of the smoke coming from wildfires to humans. Wildfires are wildland fires that can start naturally from events like lightning, but often they are caused by careless human action. When firefighters fight a wildfire, they might breathe in harmful chemicals contained in the smoke. You can see that the natural environment provides support for humans and other life most of the time. Sometimes, however, parts of the natural environment can pose a danger to humans and other living things.

Introduction

Smoke from wildland fires contains hundreds of chemicals. These chemicals can be gases, liquids, or solid forms. The chemicals that cause the most hazard to human health are carbon monoxide (mä **näk s̄id**) gas (CO), a group of gases called aldehydes (**äl duh h̄idz**), and tiny particles of solid matter that are small enough to be breathed in. The effects of breathing wildland fire smoke include eye and throat irritation, shortness of breath, headaches, dizziness, and nau-



Figures 1 and 2. Firefighters at a fire.

sea (**nä z̄e uh**). Breathing in carbon monoxide can also cause people to become mentally confused.

When firefighters fight fires, they are exposed to smoke for various lengths of time (figures 1 and 2). Some firefighters are sent to a wildfire when it first starts. These firefighters are closer to the actual fire and breathe in a lot of smoke, but typically only do so for a short amount of time. Other firefighters fight fires that have been burning for at least a few hours or days. These firefighters fight the fire for more hours at a time, but do not usually get as close to the flames or smoke. The scientists in this study wanted to measure the danger smoke poses to firefighters. They also wanted to find an easier way

for **fire managers** to estimate the danger from breathing in the dangerous chemicals found in wildland fire smoke.



Reflection Section

- What is the problem the scientists were trying to solve?
- Do you think that this problem is important? Why or why not?

Method

The scientists collected **data** from two kinds of wildfires. The first kind is called an **initial attack wildfire**, and it is the kind that firefighters are able to control within hours of being started. The second kind is called a **project wildfire**. Project wildfires take days, and even months, to control. Firefighters at initial attack wildfires work close to the fire, but they work for short periods of time. They are the emergency crews of firefighting. Firefighters at project wildfires take more time and have to develop specific plans for fighting the fires because they are so large and difficult to put out. They usually work farther away from the actual fire, but they work for longer periods of time.

The scientists gave firefighters special battery-powered equipment to wear. The equipment included three containers that collected **samples** of smoke. The containers hung on the firefighter's chest. When firefighters went to a

fire, they hung this equipment on the outside of their fire-fighting suits. While they were fighting the fire, the equipment automatically collected the smoke. The scientists took the smoke samples to their laboratories to *analyze* the smoke. The scientists were interested in two measurements. First, they wanted to know the *average* amount of different dangerous chemicals the firefighters breathed in during the time that they were fighting fires. Second, they wanted to know the maximum amount of dangerous chemicals that were breathed in at any one time.

The scientists also asked people working near the fires to estimate how much smoke firefighters were breathing in. They gave them a *scale* from 1 to 5, and asked them to assign

a number to the smoke at different times (figure 3).



Reflection Section

- Why do you think that the containers were hung on the firefighters' chests, instead of on their backs?
- What is the difference between the average and the maximum amount of something? Why do you think that the scientists wanted to know both of these measures?

Findings

The scientists measured the smoke for 30 days of wildfires. One hundred and twenty-nine firefighters wore the equipment that collected the smoke samples (table 1). Over

the 30 days, 1,763 samples were collected by the scientists. (On the average, how many samples were collected from each firefighter?)

The scientists discovered that, except for in some cases, there was not much danger to firefighters from breathing smoke. Firefighters were in danger from smoke when the wind was facing them, sending smoke in their direction. Firefighters were also in danger from smoke when they spent long periods of time putting out smoldering stumps and logs. Initial attack firefighters were in danger from smoke when they had to surround a fire quickly. These are the emergency firefighters that try to control a wildfire shortly after it starts. Fortunately, these firefighters do not spend much time in smoky conditions. This is because they usually put the fire out very quickly. The scientists discovered that there is a close *relationship* between the amount of different dangerous chemicals in smoke. When carbon monoxide levels rose, so did the levels of aldehydes and the amount of tiny particles of solid matter being breathed in (figure 4).

Figure 3. *Classification of how much forest fire smoke was in the air.*

NUMBER	SMOKE CONDITIONS
1	None
2	Light
3	Medium
4	Heavy
5	Very heavy

Table 1. *Results of smoke samples collections.*

Type of Wildfire	Number of Days	Number of Firefighters
Initial Attack	13	45
Project	17	84
Total for All Fires	30	129

Figure 4. *When carbon monoxide levels rose, the amount of particles in the smoke rose also.*

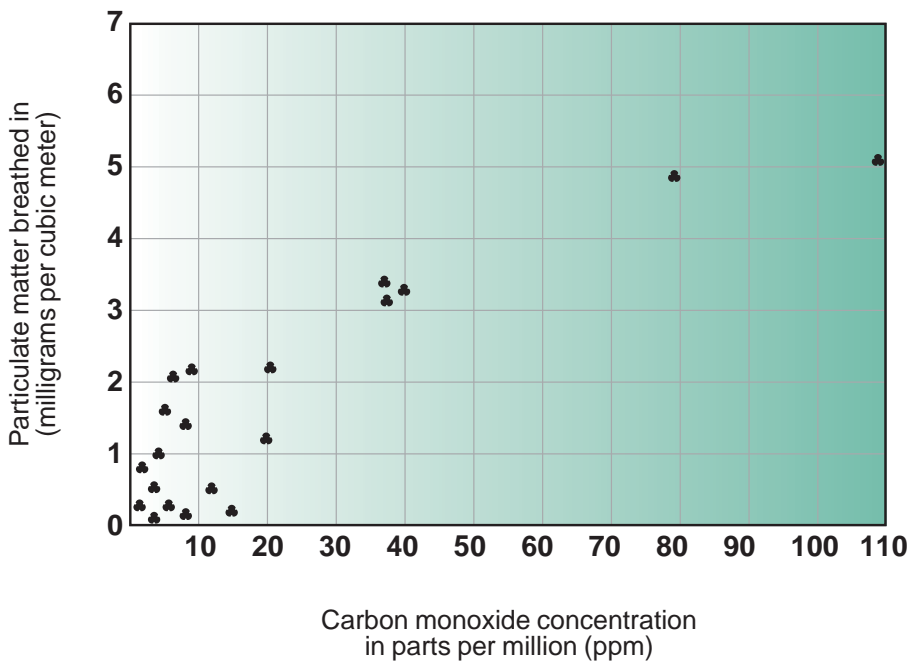

Figure 5. *No smoke.*
Rating of 1

What do you think the scientists discovered about people's ability to estimate the amount of smoke occurring near a wildfire? They found that people working near a wildfire were able to accurately estimate how smoky the conditions were. In other words, when a person gave the smoke a low rating, there were not many dangerous chemicals measured by the equipment. When a person gave the smoke a high rating, the equipment measured a high level of dangerous chemicals (figures 5-9).



Figure 6. *Light smoke.*
Rating of 2



Figure 7. *Medium smoke.*
Rating of 3



Figure 8. *Heavy smoke.*
Rating of 4



Figure 9. *Very Heavy smoke.*
Rating of 5



Reflection Section

- Based on the results of this research, do you think that

there will ever be much danger for firefighters from breathing smoke? Why or why not?

- Why do you think that it is important to know that when one dangerous chemical is measured in the smoke, there are other dangerous chemicals as well?

Implications

Although firefighters do not usually breathe in dangerous amounts of smoke, they do so occasionally. This especially happens when a wildfire has just started. Because people can estimate how smoky the conditions are, firefighters should be trained to determine when the conditions are too smoky and dangerous. If conditions are too smoky, firefighters should limit the amount of time they are breathing the smoke. Equipment should also be used that measures the amount of carbon monoxide in the smoke. By using equipment to measure the amount of carbon monoxide in the smoke, the amount of danger from many chemicals can be determined.



Reflection Section

- What are the advantages of training fire-

fighters to estimate the danger from smoky conditions over using equipment to measure the amount of dangerous chemicals in smoke?

- What are the disadvantages of having firefighters estimate the danger from smoky conditions compared to using equipment to measure the amount of dangerous chemicals in smoke?

FACTivity



The question you will answer in this FACTivity is: How consistently can you

and your classmates estimate the amount of smoke coming from a wildland fire? The method you will use to answer this question is: Examine the photographs in figures 5-9 of the article above. Pay particular attention to the amount of smoke in the photograph and the rating assigned to each. Each student will take a piece of paper and create the form at the top of the next column.

Next, each student will look at the photographs on the next page and rate the amount of smoke in each one from 1-5. Write your rating in the form beside the correct number for each photograph. After everyone is finished,

Photograph #	Rating (1-5)
1	
2	
3	
4	
5	
6	
7	
8	
9	
10	
11	
12	

nominate someone to record the ratings on the blackboard. For each photograph, record every student's rating. Now count the number of times each rating was given. For each photograph, you can create a bar chart (see example on page 13). Use the form on page 13 to record the number of ratings for each photograph.

Evaluating the bar charts should tell you how consistent you and your classmates are in your ratings of the amount of smoke from wildland fire photographs. Would you say that you are consistent, not consistent, or mixed? What is it about the bar charts that tells you that?

From Reinhardt, T. E. and Ottmar, R. D. (2000). Smoke exposure at western wildfires. Res. Pap. PNW-RP-525. Portland, OR: U.S. Department of Agriculture, Forest Service, Pacific Northwest Research Station. 72 p.



Photograph #1



Photograph #2



Photograph #3



Photograph #4



Photograph #5



Photograph #6



Photograph #7



Photograph #8



Photograph #9



Photograph #10



Photograph #11



Photograph #12

Photograph #	No. of 1's	No. of 2's	No. of 3's	No. of 4's	No. of 5's
1					
2					
3					
4					
5					
6					
7					
8					
9					
10					
11					
12					

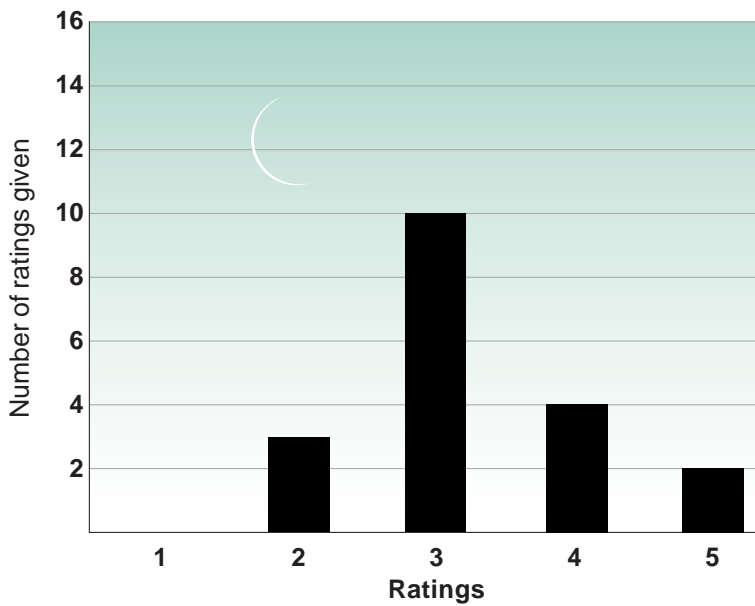

Example of bar chart

Photograph 1 1 = No smoke, 5 = Very heavy smoke

Fire Safety Tips

Here are some tips from the Arkansas Fire Prevention Commission (kuh **mish** un) to help keep you safe from uncontrolled fires in your home:

1. Plan two escape routes out of your home and practice using them.
2. Be sure you can open all doors and windows from the inside.
3. Call the fire department **AFTER** you have left the building.

4. **DON'T** stop to get valuables.
5. Never re-enter a burning building.
6. Plan a place to meet outside of your home.
7. If your clothing catches on fire, stop, drop, and roll. Do not run. Call for help.

The Story of Smokey Bear



When a Japanese submarine shelled the southern California coast during World War II, people were worried that more attacks might start forest fires. So the USDA Forest Service began a program to make everyone aware of the dangers of forest fires. They wanted an animal to represent forest fire prevention and they decided on a bear. This bear was to

have a short nose, be brown or black, and have a face that looked smart and friendly. They also wanted him to wear a ranger hat and blue jeans. They named this bear “Smokey” after “Smokey Joe” Martin, a fire chief from the New York City Fire Department.

Until 1950, Smokey was just a character drawn on posters asking people to help prevent forest fires. Then in 1950, someone was careless with a match, cigarette, or campfire in the Lincoln National Forest in southern New Mexico. This was the start of a terrible forest fire. After the fire passed and the smoke cleared, the only liv-

ing thing the firefighters saw was a badly burned bear cub clinging to a blackened tree. The little bear was taken to the ranger station, where people bandaged his burned paws and helped him to become healthy again. They called this cub “Smokey,” and he became the first living symbol of Smokey Bear.

When Smokey’s burns healed, he was sent to live at the National Zoo in Washington, DC. Over the years, thousands of people from around the world came to see Smokey Bear. Smokey died in 1976, and he is buried near his original home in southern New Mexico at Smokey Bear State Park.



Fighting Fire with Fire:

Protecting the Homes of People and Birds



Meet Dr. Beyers:

I like being a scientist because I never get tired of asking questions and trying to answer them. The questions I like to answer are things like, “Why do plants and animals live where they do?” and “How do human activities and *land management* decisions affect animals living in the wild?” Plus, I get to run around in the woods and the *scrub* and wear jeans all the time!

Glossary

land management (land man ij ment): Decisions and actions involving natural lands to achieve specific purposes.

scrub (skrub): An area with short, stubby trees or bushes.

mammals (mam uls): Warmblooded animals that have a backbone; Female mammals have glands to produce milk for feeding their young.

ecologist (e käl uh jist): A person who studies the relationship between living things and their environment.

habitat (hab uh tat): Environment where a plant or animal naturally grows and lives.

threatened (threh tend): Legal term meaning the existence of the species is likely to become endangered in the future.

species (spe sez): Groups of organisms that resemble one another in appearance, behavior, chemical processes, and genetic structure.

wildfire (wild fir): An uncontrolled wildland fire started naturally or by careless human action.

climate (kli met): The average condition of the weather at a place.

nonnative (nän na tiv): Not naturally occurring in an area.

adapt (uh dapt): To change so as to fit new conditions.

randomly (ran dum le): A way of selecting a smaller number from a group in such a way that all members of the group have the same chance of being selected.

extinction (ik stin(k) shun): No longer existing.

conserve (kän sürv): To avoid wasteful or destructive use of something.

consensus (kän sen sus): Agreement of all or most.

Pronunciation Guide

a	as in ape	ô	as in for
ä	as in car	u	as in use
e	as in me	ü	as in fur
i	as in ice	oo	as in tool
o	as in go	ng	as in sing

Accented syllables are in bold.



Meet Dr. Wirtz:

I like being a scientist because ever since childhood I have loved *mammals* and birds and the outdoors. By training to be an *ecologist*, I have a career that allows me to study the things I love most. I can also work outdoors, and travel to places like Africa and Australia.

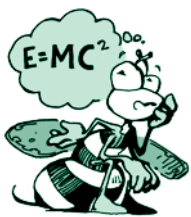

Thinking About Science

The natural world holds many secrets. Although scientists study

just about everything you can think of, there is still a lot to learn. In this study, the scientists wanted to learn about the *habitat* of the California gnatcatcher, a small grey bird that lives in a particular area along the coast of California (figure 1). This little bird is listed as *threatened* by the U.S. Government. In 1993, a *wildfire* burned 10,000 hectares of land. (To figure out how many acres this is, multiply 10,000 X 2.47.) The wildfire killed 330 of the

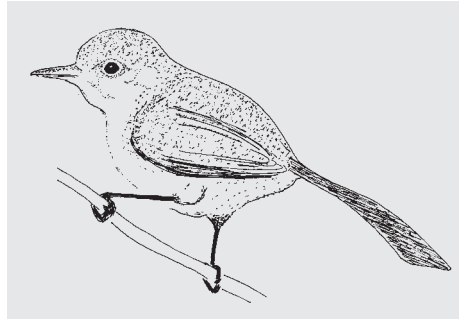

Figure 1. *California gnatcatcher*

2,200 pairs of gnatcatchers. (What percentage of the gnatcatcher pairs were killed? Divide 330 by 2,200 to find out.) The scientists wanted to know how any future fires would affect the remaining birds.

When scientists begin to study a problem, they always learn as much as possible about their subject. They do this by going to the library, just like you do when you write a class paper for school. The scientists found out that people do not know very much about what the gnatcatchers eat and where they live. As you can see, scientists learn not just from observing things and doing experiments, they also learn by reading and studying.



Thinking About the Environment

Along the central and southern pacific coastline of California, there is an area of land that has a lot of different kinds of shrubs growing on it. Altogether, these shrubs are called coastal

sage scrub (figure 2). The *climate* in this area is hot and dry, and the shrubs usually do not grow higher than 2 meters. (Calculate how many feet this is by multiplying 2 X 3.28.) By the end of the summer, the shrubs become dry and brittle from the hot summer sun, and they often lose their leaves from the heat. The southern California coastal area is a place where people like to live and work, mainly because the weather is warm there all year, and the ocean is not far away. When people build houses and businesses on land, they change the land. When people build houses and businesses on land with coastal sage scrub, they remove the shrubs and replace them with buildings, roads and parking lots, and grass and other *nonnative* plants. This might not seem bad for people, but it is not good news to the California gnatcatcher. This little bird needs coastal sage scrub to reproduce. When people change the land, they almost always affect the plants and animals that live there.

Introduction

The California gnatcatcher is a little bird with a big problem. Its habitat has been reduced 80 percent by people that are building homes and businesses in coastal southern California. The bird's habitat consists of shrubs that can become very dry and brittle, especially during the summer. Wildfires are more likely to



Figure 2. *Coastal sage scrub.*

occur when shrubs are dry and brittle. When a wildfire burns an area of coastal sage scrub, the gnatcatchers cannot use the area for about 5 years (figure 3). They have to live somewhere else until most of the shrubs grow back. People that live and work close to areas of coastal sage scrub can also be hurt by wildfires. Wildfires sometimes damage or destroy their homes and businesses.

Although wildfires cannot always be prevented, there is a lot that people can do to reduce the strength of a fire. Have you ever heard the term “fighting fire with fire”? That’s exactly what people do to reduce the threat of a wildfire. They purposely set fires in areas without letting the fire get too big or out of control. That way, if a wildfire gets started, it will not have as much fuel to burn, and people

can more easily put it out. The scientists in this study wanted to know how these purposely set fires, called prescribed (pre **skribd**) fires, affect the California gnatcatcher.



Figure 3. *Coastal sage scrub still recovering after a fire. Compare this photograph with the photograph in figure 2. In the area pictured here, there is not enough scrub for gnatcatchers to live and reproduce.*

Because the gnatcatcher is a threatened *species* that lives only in coastal sage scrub areas, it is important to protect as much of its habitat as possible.



Reflection Section

- What question are the scientists trying to answer?
- Do you think that prescribed burns help or hurt gnatcatchers? Why or why not?

Methods

The scientists drew a line on a map around the area with coastal sage scrub in southern California (figure 4). Then, on the map, they identified smaller areas within the larger area to study. They wanted to

Fire Facts

Many people build their homes in areas in or near a forest or other natural area, such as a prairie or in coastal sage scrub. When homes are built in these areas, they are more likely to be damaged by a wildfire. Many homeowners want people that manage the land to put out all wildfires. Although putting out wildfires seems to be good for homeowners, it is not always the

best thing for the land. Many lands need fire to be healthy. Many plants cannot reproduce until heat from a fire opens their buds or cracks their seeds. Fire helps release needed minerals in the soil, which are then used as nutrients by plants. Fire opens shaded areas in the forest, allowing sunlight in and encouraging new growth. In addition, most animals avoid being burned in a fire. Fortunately, there is a way to protect homes and at the

same time get the benefits of fire. Managers can purposely set controlled fires every few years. These fires reduce the amount of burnable material available if there is a large wildfire, making it easier to put out the wildfire. When fires are purposely set as part of land management, the land gets the benefits of fire and human communities are protected.



Figure 4. Area where coastal sage scrub grows (dark green) and areas studied (white birds).

study places throughout the area of coastal sage scrub, so they selected areas near the ocean and farther inland (figure 4). The scientists selected areas where gnatcatchers were known to live and areas where no gnatcatchers had been living.

As you can see in figure 4, five areas were studied. Some of these areas had been recently burned and others had not been burned. Within each of the 5 areas, 200 specific points were *randomly* identified. At each point, the type of coastal sage scrub or other vegetation was identified and the height of the vegetation was recorded.



Reflection Section

- Why do you think that the scientists only studied five areas within the larger area of coastal sage scrub? Why would they not study the entire area?
- Look at figure 4. What large city is included in the coastal sage scrub area?

Findings

California gnatcatchers prefer to live in areas that have more than 50 percent of the ground covered in coastal sage scrub. If an area had less than 40 percent of the ground covered in shrubs, gnatcatchers did not live there. Coastal sage scrub had to be at least 1 meter high in an area for gnatcatchers to live there. (To find out how many feet this is, multiply 1×3.28 .) If an area with less vegetation was close to an area with more vegetation, gnatcatchers would sometimes go into the area with less vegetation to look for food.

The scientists suspect that gnatcatchers need areas with more vegetation because insects do not live in areas with less vegetation. Insects are the gnatcatcher's main

source of food. After fire burns an area of coastal sage scrub, the shrubs are burned to the ground. The shrubs can grow back, but it takes them about 5 years to grow 1 meter high. California gnatcatchers cannot live in an area that has been burned until about 5 years following the fire.



Reflection Section

- How many feet are in 1 meter? (Hint: You can find out by reading the “Findings” section.)
- Why do you think that gnatcatchers cannot live in an area that has been burned until about 5 years after the fire?

Implications

The California gnatcatcher’s habitat is reduced when people build homes, other build-

ings, roads, and parking lots in areas of coastal sage scrub (figure 5). Once buildings are built near coastal sage scrub, people want to reduce the risk of wildfire to those buildings. One way to do that is to set prescribed fires in the coastal sage scrub areas that are close to buildings. The fire will burn most of the fuel away. Then, if a wildfire does occur in the coastal sage scrub, it will not be able to reach any buildings.



Reflection Section

- Do you think that the habitat of the California gnatcatcher should be conserved? Why or why not?
- How do you think that purposely setting fire in the natural areas near buildings protects those buildings from wildfires?

FACTivity



The question you will try to answer with this FACTivity is: What should be done when

the habitat of a threatened bird is in conflict with the safety of people’s homes? The method you will use to try to answer this question is: Divide your class into two discussion groups and one decision group. Each discussion group will take one of the following positions:

Group 1: People’s homes are much more important than conserving the habitat of a bird, even if it is threatened. Therefore, wildfires must be controlled by reducing the amount of fuel available. This must be done by frequently burning areas of coastal sage scrub surrounding people’s homes. If this burning takes away a threatened bird’s habitat, that is the way it has to be.

Group 2: When people build homes in areas that are likely to have wildfires, they take the chance that their homes will be burned by a wildfire. We should leave these areas alone. If a wildfire occurs, we can then go into the coastal sage scrub areas and put the fire out. Until then, we should let nature take its course.

The two discussion groups should meet separately for at least 10-15 minutes to develop an argument to support their position. One person should be appointed the spokesper-



Figure 5. Coastal sage scrub with buildings nearby.

son for the group, and another person should record what the group members say during their discussion.

The third group will make the decisions. This group will decide which course of action to take based on the presentations of the other two groups. While the two discussion groups are developing their arguments, the third group must decide how they will choose a course of action. Will they vote and allow the majority to rule? Will they insist on *consensus*? Will one person make the decision for everyone else? After the 15 minutes

has passed, the first two groups will each present their argument to the third group. The decision-making group will then make a decision, and explain why and how they made their decision. The decision-making group may choose parts of more than one option when making their decision.

Note: People often disagree about the best course of action to take to solve a problem. This FACTivity is similar to the process communities across the United States take to decide on a course of action. Many communities

have locally elected commissions (kuh **mish** uns) that serve as the decisionmakers. What is the name of the body that makes these kinds of decisions for the United States as a whole? (Hint: It is made up of people elected from across the United States, and it is divided into two houses.)

From: Beyers, J. L. and Wirtz, W. O. II. (1997). Vegetative characteristics of coastal sage scrub sites used by California gnatcatchers: Implications for management in a fire-prone ecosystem. In: *Proceedings: Fire Effects on Rare and Endangered Species and Habitats Conference*. Coeur d' Alene, Idaho: November 13-15, 1995, 81-89

Fire Facts: Writing a Prescription for Fire

When you are sick and go to the doctor, the doctor might prescribe medicine or some other action to help you to become healthy again. Prescribed fire (a fire that is started on purpose) works in a similar way. But why start a fire on purpose? Fire is one way to help restore health to a forest. If trees are too crowded, if there are too many dead leaves and branches on the forest floor, or if insects and disease have become wide-

spread, the forest may need help from fire. Land managers only prescribe fire when the weather conditions are right. Long before a fire is lit, prescriptions are made for different types and locations of forests. The prescription describes what the condition of the forest should be after burning. Factors to consider are the locations of homes and other buildings, weather forecasts, wind speed, humidity, the amount of moisture in the

trees, and the types of trees and plants. Before fires are started on purpose, the forest conditions have to be measured to see if they meet the prescription for that type of forest. Burning begins only when conditions are right. If the weather conditions change quickly or the fire does something unexpected, firefighters reduce the flames or put the fire out.

Time Will Tell:



Does Wildfire Damage the Prairie?



Meet Dr. Ford:

I like being a scientist because I love to read, write, and explore, and I have fun learning about our planet Earth and how it works.

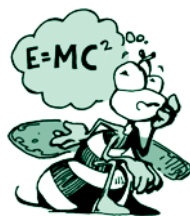

Thinking About Science

There are many ways to investigate a question or problem. When a scientist decides to study a problem, he or she must make many decisions. One decision a natural resource scientist must make has to do with time. Over how long a period should the problem be studied? Should the problem be studied over an hour's time? For 1 week? Or, should the problem be studied over a period of years? The scientist in this study observed the impact of her experiment on

Glossary

ecosystem (e kō sis tem): Community of plant and animal species interacting with one another and with the nonliving environment.

prairie (prair e): Large areas of grasslands with fertile soils and few trees.

forage (for ij): Food for animals usually taken by browsing or grazing; Act of taking such food.

wildfire (wild fir): An uncontrolled wildland fire started naturally or by careless human action.

sample (sam pul): Part or piece that shows what the whole group or thing is like.

species (spe sez): Groups of organisms that resemble one another in appearance, behavior, chemical processes, and genetic structure.

rodent (rō dent): An animal having sharp front teeth for gnawing.

live-traps (liv traps): Devices used to trap an animal without harming it.

evolved (e volvd): Developed by gradual changes.

land managers (land man ij ürs): Skilled individuals that take care of natural resources.

Pronunciation Guide

a	as in ape	ô	as in for
ä	as in car	ü	as in use
e	as in me	ü	as in fur
i	as in ice	oo	as in tool
o	as in go	ng	as in sing

Accented syllables are in bold.

the natural environment immediately after the experiment was over. She also observed the same natural area 1 year later. Then, she observed it again after more than 12 months. Do you think that the natural area had changed during the time that she observed it? Do you think that her conclusions about the experiment changed over that period of time? Why or why not?

Fire Facts

Fire was a normal occurrence in most plant-based ecosystems in the United States. The plants in these ecosystems *evolved* to resist fire, and even thrive under the effects of fire. An example of an ecosystem that needs fire is the tallgrass prairie. The tallgrass prairie grew in parts of Nebraska, Illinois, Iowa, and Kansas. The tallgrass prairie

is mostly grasses and forbs. Forbs are low-growing plants with broad leaves. In the past, every 5 to 10 years a fire would naturally occur. These fires were probably started by lightning. The fire would kill the woody plants that had begun to grow, such as trees, shrubs, and most vines. These woody plants, had they grown, would have shaded out and killed the grasses and forbs. When fires are not

allowed to burn in a tallgrass prairie, woody plants grow and replace the grasses and forbs. *Land managers* purposely set fire to prairie ecosystems about every 2 or 3 years. They set these fires in April, so that the grasses will grow back during the summer growing season. That way, the prairie ecosystem will continue into the future.



Thinking About the Environment

One possible characteristic of an *ecosystem* is

the ability to withstand a sudden crisis without changing very much. This characteristic is called resilience (*re zil yentz*). An example of a resilient (*re zil yent*) ecosystem is a natural sandy beach.

When a storm or a hurricane hits, the beach may change its shape by losing or gaining sand. Overall, however, a sandy beach is resilient to storms and does not change very much in the long run. Another example is a flood plain, the flat land area on either side of a river. When the flood plain is not disturbed by human activities, in the long run it does not change very much when the river overflows its banks during a flood. The scientist in this study wanted to know whether a *prairie* is resilient to fire.

Ecosystems are not the only things that may be resilient to a sudden crisis. What are other examples of resilience?

Introduction

Prairies are grasslands that are often used as *forage* for cattle (figure 1). When a *wildfire* burns across a prairie, the grass is killed immediately and there is no forage for cattle. Because of this, many people thought that prairies were changed by fire. The scientist in this study believed that prairies are resilient to fire. She thought that people did



Figure 1. A prairie.

not wait long enough after a fire had burned to determine whether the fire had changed the prairie. The questions the scientist wanted to answer are: 1) How does wildfire change a prairie? 2) How long does it take a prairie to recover after a wildfire? 3) In addition to immediately killing the prairie's plants, does a wildfire affect the type of animals that live on the prairie?

Reflection Section



- If you were the scientist, how would you study the resilience of a prairie to fire?
- Do you think that prairies are resilient to fire? Why or why not?

Method

The scientist studied an area of prairie in New Mexico that covered 160 hectares (figure 2). (To find out how many acres this is, multiply 160 X

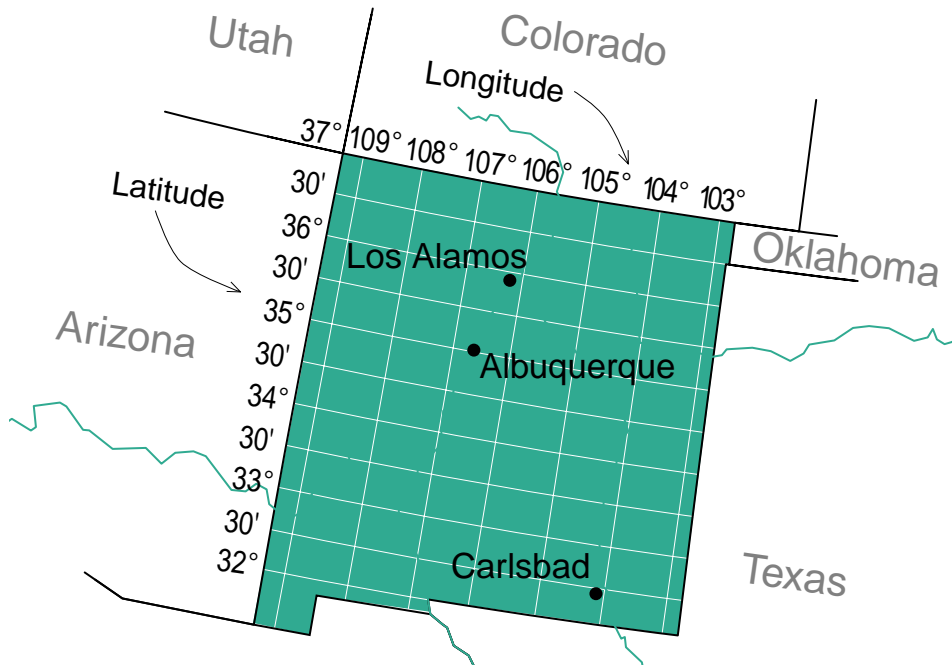

Figure 2. Map of New Mexico with lines of latitude and longitude. Latitude consists of imaginary lines around the Earth from the equator to the poles. Longitude also consists of imaginary lines around the Earth. Each line of longitude circles the Earth through both the North and South Pole. These lines are used to identify locations on the Earth. Both latitude and longitude are identified by degrees (°), minutes ('), and seconds ("). The study area for this project was 36°, 31' latitude north, 103° 3' longitude west. See if you can locate where in New Mexico the scientist conducted her study.

2.47.) Within this area, the scientist marked off 12 separate *sample* areas that covered 2 hectares each. Four of these areas were purposely burned in April of 1997 (figure 3). This was before the prairie grasses had begun their spring growth. Four more areas were burned in July. In July, the grasses were in the middle of their growing season. The last four areas were left unburned. The scientist used these unburned areas to compare with the burned areas. When the scientist burned the areas, she did not allow the fire to burn more than the sample area.

The scientist observed and measured six things. The six things she measured were: 1) What percentage of the ground was covered by prairie grass, 2) What kind of grasses were growing in the area, 3) How many different *species* of beetles were living in the area (figure 4), 4) How many beetles of each species were living there, 5) How many different species of *rodents* were living in the area (figure 5), How many rodents of each species were living there. The scientist measured these six things five different times (table 1).



Figure 3. A research assistant purposely setting fire to an area of prairie.

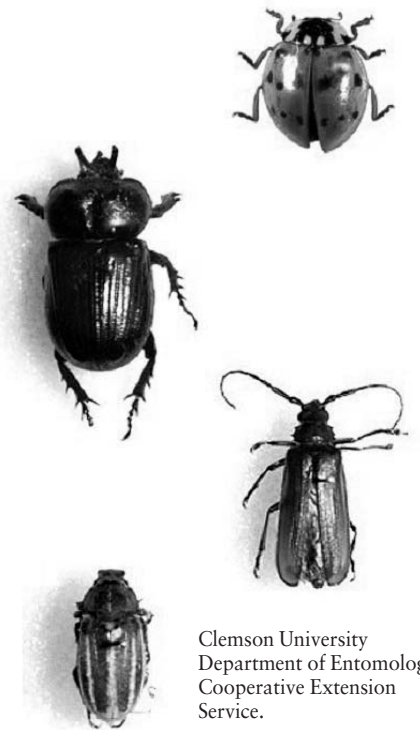

Clemson University
Department of Entomology
Cooperative Extension
Service.

Figure 4. Beetles that can be found living on the prairie.

The scientist used *live-traps* to catch the rodents. After she put a numbered tag on the rodent's ear and took body measurements (such as weight, color, and sex), she released the rodent back into the area.

Table 1. The dates that the scientist took measurements.

Period	Date
1	March 1997 (Before any areas were burned)
2	April-June 1997 (After the first set of areas were burned)
3	July-October 1997 (After the second set of areas were burned)
4	July-October 1998 (1 year after the second set of areas were burned)
5	October 1999 (Over 2 years after the second set of areas were burned)



Reflection Section

- Why do you think that the scientist put a numbered tag on each rodent's ear before releasing him or her?
- Why do you think that the scientist took measurements after 1 year and after 2 years?

Findings

Before any areas were burned, the scientist found that 10 species of beetles made up 90 percent of the beetles living there. Overall, however, there were 115 species of beetles living in the areas. (How many beetle species made up the last 10 percent?) Although the scientist found nine total species of rodents living in the

areas, most of the rodents were northern grasshopper mice, thirteen-lined ground squirrels, or plains harvest mice (figure 5). Each of the 12 areas had about the same number and variety of beetles and rodents.

Immediately after the April fires, the grass cover in the burned areas was killed. By July, however, the grass in those areas had grown back and looked like the grass in unburned areas. The areas that were burned in July also lost their grass cover after the fire. For 2 years following the fire, there was still much less grass cover in those areas than in unburned areas. However, by 2.5 years after the fire, those areas once again looked like unburned areas.

Immediately after the fires, the scientist noted that the number and variety of rodents had been reduced. By 1.5 years after the fires, however, the number and variety of rodents was similar to the unburned areas. Up to 1.5 years following the fires, the number of beetles increased. By 2.5 years following the fires, the number and variety of beetles was the same as the unburned areas.



Reflection Section

- By 2.5 years after the fires, what had happened to the areas of prairie that had been burned?
- What happened to the areas immediately after the fires?

Bill Gannon



Bill Gannon



Figure 5. Thirteen-lined ground squirrel, plains harvest mouse, and grasshopper mouse.

- Why do you think that vegetation in the areas that were burned before the growing season regrew faster than vegetation in the areas burned during the growing season?

Implications

The judgments that people make about something may depend upon the length of time between the event and their judgment about it. This is the case for judging whether prairies are resilient to fire. Immediately after a fire, the prairie looks very different. Its grasses are gone and there are few rodents living there. After 2.5 years, the prairie has recovered so much that a person can hardly tell that a fire ever occurred. If a person's timeframe for judging resilience is a few months, the prairie is not resilient to fire. If a person's timeframe for judging resilience is a few years, the prairie is resilient to fire. Since wildfires are a natural part of what happens on a prairie, it is no surprise that over time the prairie is resilient to fire. Think about your own judgments. When you have an argument with a friend or you make a lower grade than you expected, you

immediately judge the event one way. Later, after you have had time to think about it, your judgment may change. Thus, when making a judgment about an event, people should always remember that the judgment may change, depending on how long after the event it is made.



Reflection Section

- Are your fingernails resilient to breakage? How do you know? Do they seem resilient immediately after being broken?
- How are broken fingernails like a prairie that has been burned by a wildfire? How are they different?



Discovery FACTivity

The question you will answer through this FACTivity is: What are some similarities and differences in examples of resilience? The method you will use to answer this question is: Divide your classroom into three or four groups. Each group will take 10 minutes to observe exam-

ples of resilience in your classroom and outside your classroom window. For example, remember that your fingernails are resilient to breakage. Another example might be the grass outside, which is resilient to being cut. In each case, estimate the amount of time it takes for the resilience to show, or for the thing to appear as it did before the sudden change occurred. Record your observations using the form on the next page.

Now, compare the lists that each group developed. What are the similarities between all of the resilient objects? How are they different? Compare the amount of time it takes for the resilient items to show resilience. What does this exercise tell you about the characteristic of resilience?

For more information about fire resilience in Yellowstone National Park, visit www.discovery.com/stories/nature/yellowstone/yellowstone.html.

From Ford, P. L. (2001). Scale, ecosystem resilience, and fire in shortgrass steppe. Pp. 447-456. In: *Ecosystems and Sustainable Development III*. C.A. Brebbia, Y. Villacampa, and J-L Uso (eds.). Series: Advances in Ecological Sciences, Vol 10. WITPress Southampton, Boston. 824 pp.

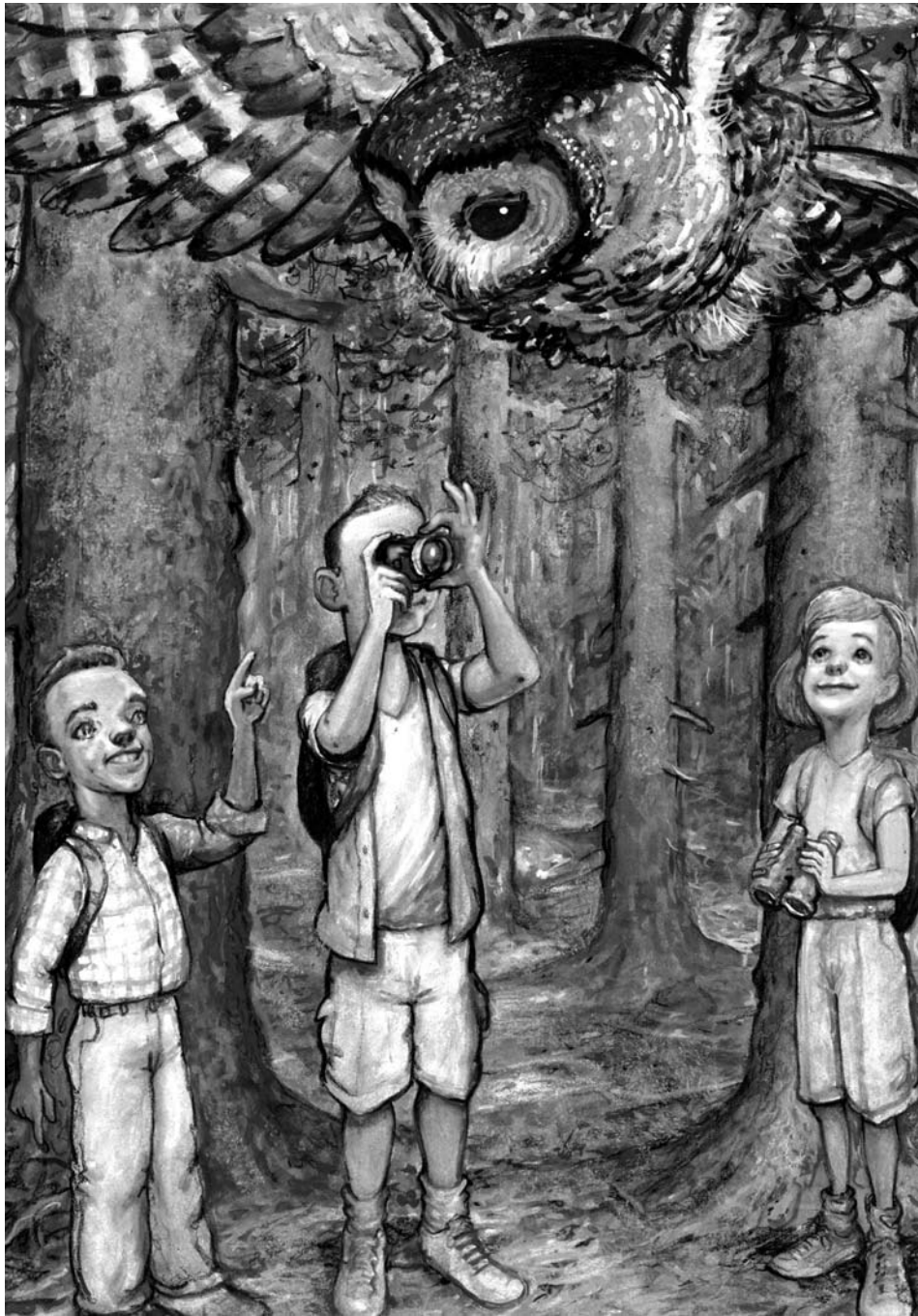

Who Gives a Hoot?

Determining the Value of Owl Habitat

Glossary

endangered species (n dan jüerd spē shez): Wild plants or animals with so few individual survivors that the species could become extinct in the area where it naturally lives.

economic (ē kō nom ik): Having to do with the management of money in a home, business, or government.

psychology (sī kōl uh je): The science that studies the ways that people think and the reasons for their actions.

sociology (so sē ôl uh je): The study of people living together in groups.

economics (ē kō nom iks): The study of the way that goods and wealth are produced, distributed, and used.

conservation (kän sūr va shun): The care and protection of natural resources such as forests and water.

mammals (mam uls): Warm-blooded animals that have a backbone; female mammals have glands to produce milk for feeding their young.

old-growth forests (ôld grōth fôr ests): Forests that contain trees that are hundreds or sometimes thousands of years old.

wildfire (wīld fir): An uncontrolled wildland fire started naturally or by careless human action.

forest managers (fôr est män ij ürs): Skilled individuals that take care of natural resources.

vegetation (vej uh ta shun): Plant life.

represent (rep re zent): To be an example of.

Pronunciation Guide

a	as in ape	ô	as in for
ä	as in car	u	as in use
e	as in me	ü	as in fur
i	as in ice	oo	as in tool
o	as in go	ng	as in sing

Accented syllables are in bold.



Dr. Loomis

Meet Dr. Loomis:

I like being a scientist because I like solving puzzles about human behavior. I am interested in how much people value clean air and water, and protecting the environment for things like hiking and as homes for *endangered species*. People cannot buy resources like clean air in stores, so it is hard to put a price tag on them. As a scientist, I play detective to discover these values by asking people questions.

decisions about the natural environment. I discover how people feel about the environment by asking them questions. As a scientist, I get to travel to interesting places all over the world, including Chile, Peru, Mexico, Spain, Russia, Portugal, and Ghana!

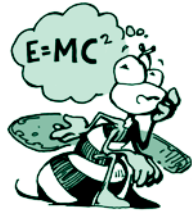

Thinking About Science

When people think about science, they usually think about topics like biology, chemistry, and astronomy. These topics are grouped into a category of science that deals with physical aspects of all life. There is another category of science that includes topics that deal with human behavior, such as *psychology*, *sociology*, or history. You study these kind of topics in

Social Studies class. Scientists call these kind of topics social sciences. In this study, the scientists investigated the economic behavior of people. *Economics* is a social science built on the idea that people spend money on things that are important to them. The scientists asked people if they would be willing to spend money on environmental *conservation*. By doing this study, the scientists gained a better understanding of how important the environment is to different people.



Thinking About the Environment

Have you ever seen Mt. McKinley (also called Denali [duh nă lē]) in Alaska? Have you ever seen Yellowstone National Park in



Dr. González-Cabán and son Omar

Meet Dr. Armando González-Cabán:

I like being a scientist because it is fun to play detective and try to understand how people make *economic*

Fire Facts: Forest Fuels

Within a forest, forest fire fuels are not all the same. They sit in layers, kind of like a three-layer cake. Ground fuels are found beneath the surface of the soil, and include materials like tree roots and decaying matter. Surface fuels are found at the top of the soil level, and include grasses, fallen needles and leaves, decaying wood, and other vegetation. The top layer of fuels is above the level

of the soil and includes branches, dead trees, and treetops (called crowns). When a fire begins to burn the top layer of fuels, it can spread quickly. When you see a photograph of a large wildfire with flames in the crowns of trees, that kind of fire is called a crown fire. Prescribed fires, which are strictly controlled, burn only the surface fuels. Prescribed fires leave the large trees standing and unharmed.

Wyoming? How about the Amazon River in Brazil or the Sahara Desert in Africa? You might not have ever seen any of these natural places, but you still might think they are valuable. You might think they are valuable because you would like to visit them one day. Or maybe you think they are valuable because they provide homes for wildlife. You might not think they are valuable at all. Natural areas have a lot of different kinds of value to humans. Some people might think that forests are valuable because they provide wood for building homes, or

because they provide homes for birds and *mammals*. As you can see, people might think the environment is valuable for a lot of reasons.

Introduction

The northern spotted owl is an endangered species that needs *old-growth forests* in the Pacific Northwest to live (figures 1, 2, and 3). Unfortunately, old-growth forests, like all forests, may catch fire and be damaged or destroyed. Scientists estimate that over a 100-year period there is a 70 percent chance of a large *wildfire* burning a for-

est so that northern spotted owls can no longer live there. (What does it mean to say that there is a 70 percent chance of something happening?) There are many things *forest managers* can do to reduce the risk of a large forest fire. One of the best ways is to use what managers call prescribed (pre *skribd*) fire. These are small fires that burn the lower forest *vegetation* but leave the large trees standing. Prescribed fires are purposely started and are strictly controlled by forest managers.

By purposely burning the vegetation that grows near the



Figure 1. Northern spotted owl.



Figure 3. The Pacific Northwest of the United States.

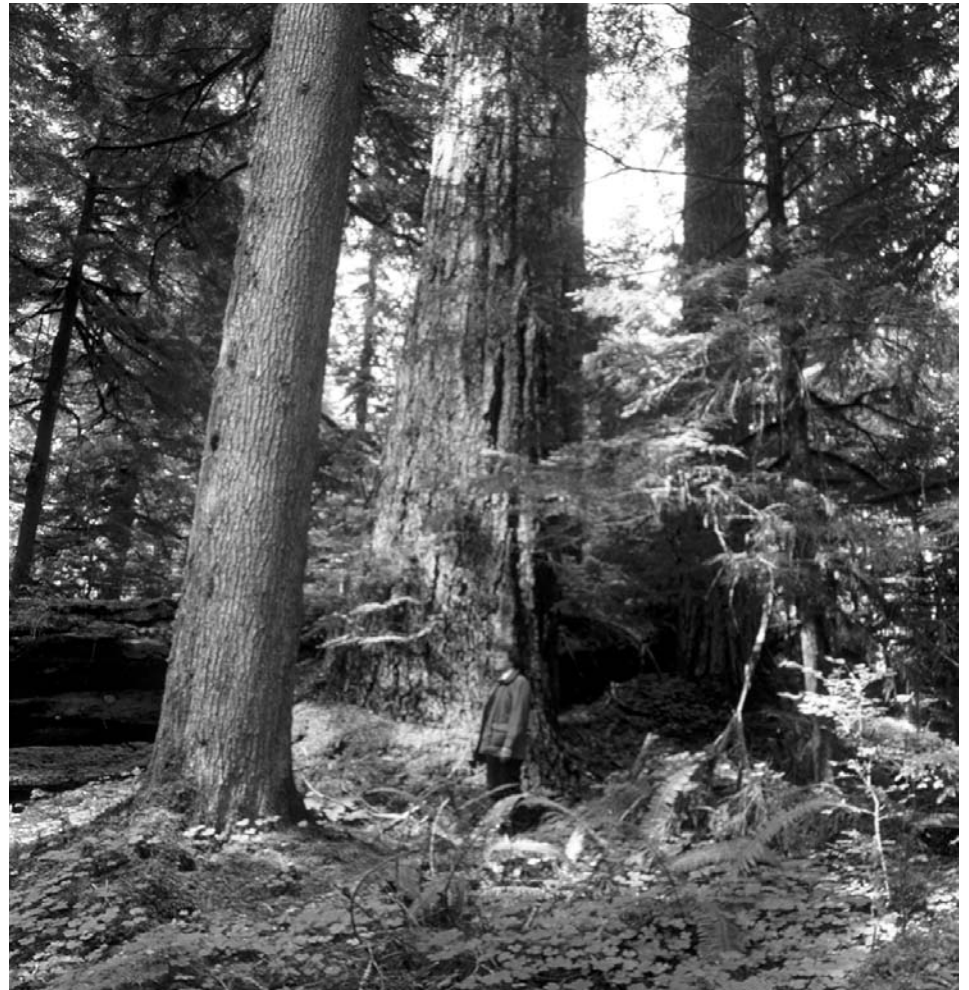

Figure 2. Old-growth pine forest that provides habitat for the northern spotted owl.

ground, the total amount of wood fuel is reduced. That way, the old trees that the owls need are left standing and the area is better protected from large fires.

Unfortunately, prescribed fires cost a lot of money. As you can see, this can be a big problem. If managers leave the old-growth forests as they are, there is a risk of a large forest fire destroying the owls' habitat. The owls would have no place to live. Managers could conduct prescribed fires if they had money. The scientists in this study wanted to know whether people like you and your family and friends value the endangered owl's habitat enough to support spending more of our tax money on prescribed fires.



Reflection Section

- What is the question the scientists are trying to answer?
- Do you think that it is important to protect the habitat of an endangered species like the northern spotted owl? Why or why not?

Methods

The scientists designed information that explained how the risk of fire could be reduced in old-growth forests. Then, the scientists developed information that they hoped would help people think about the reasons they might value old-growth forests (see "Thinking About

the Environment," above). For example, they asked people to think about the beauty of the forest, the use of the forest for wood products such as furniture, and the forest as a home for wildlife. The scientists asked people if they would pay money to reduce the risk of a large wildfire in old-growth forests.

The scientists put the information and the questions into a booklet and sent the booklet to a random sample of people in California and New England (figure 4). When the scientists picked their random sample, it means that all of the people living in California and New England had an equal chance of being selected to receive the information. However, only a small per-

Fire Safety Tips from Smokey and His Friends at the United States Fire Administration!

Although Smokey wants you to prevent wildfires, he also wants you to prevent uncontrolled fires in your home. Every year, almost 100,000 fires are started by kids. Here are some tips to help you prevent uncontrolled fires in your home:

1. Do not play with lighters, matches, or candles.
2. Remind adults to turn pot handles toward the center of the stove. Pot handles should never hang over the

edge where someone could bump them and knock them off of the stove.

3. Never put anything over a lamp, like clothes or a blanket, not even when you are playing.

4. Don't stand too close to a fireplace or a wood stove.

5. Ask adults to install smoke alarms, if you do not have them, in your house.

6. Remind the adults in your household to change smoke alarm batteries every spring and fall.

7. Don't play with electrical cords.

8. Never stick anything into an electrical socket except an electrical plug.

9. Turn off electrical equipment when you are finished using it.





Figure 4. The State of California and the area of New England.

centage of the total number of people living in the areas received the booklet. The people that received the booklet were assumed to *represent* everyone in California and New England. You can do the same thing with a bag of M&Ms® candy. If you shake

the bag right before you pick out an M&M®, and you pick five M&Ms®, (shaking the bag in between), you can assume that the five pieces closely represent the number and proportion of colors in the rest of the bag of candy.

Findings

Once the scientists had collected the responses from their sample, they calculated how much money people said they would be willing to pay to reduce the risk of a large wildfire in old-growth forests. From all of the responses, the scientists calculated the mean (or average) and the median amount that people said they would pay (figure 5). (What is

the difference between the mean and the median? ¹⁾ [When you see a small number following a word as you see it here, that means that further information is provided at the bottom of the page. Look for the small number at the bottom of the page for more information about the mean and median!]

In the calculation above, the scientists did not include the responses of people that did not respond to their questions. The scientists assumed that the people that did not respond would not be willing to pay anything. Therefore, the average and median amounts that they used were lower than the values in figure 5. The scientists took the lower average amount and multiplied it by the number of people living in each area. Then, they divided the total amount by the number of hectares of protected old-growth forest in California and Oregon. By doing this, they were able to estimate how much money people living in California and New England would be willing to pay per hectare to reduce the risk of wildfire in California and Oregon (table 1).

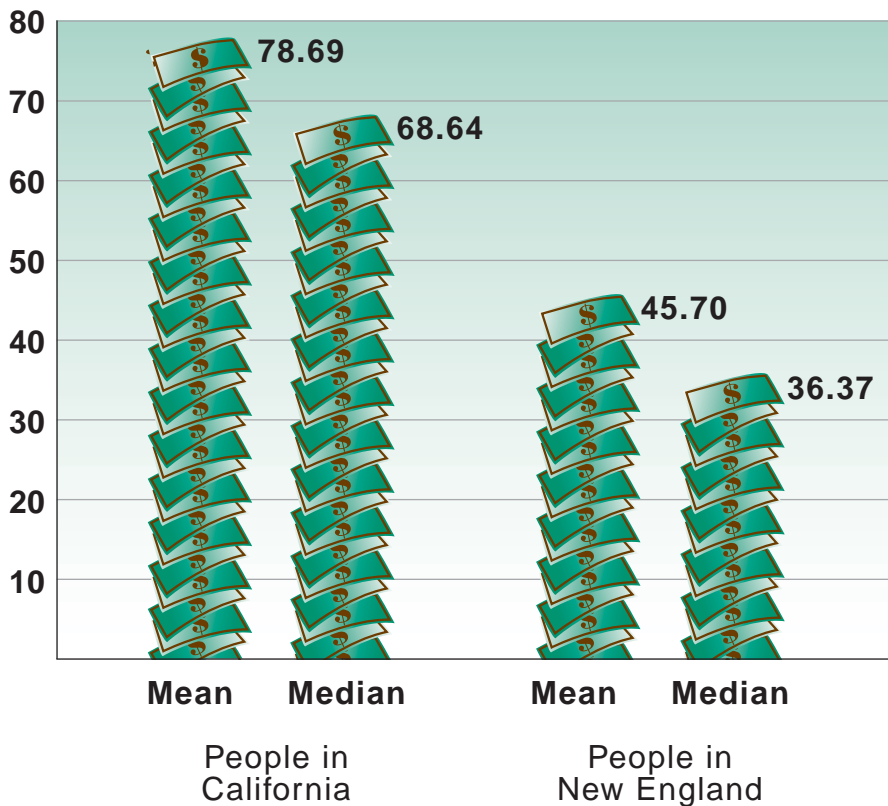

Figure 5. Amount people in California and New England are willing to pay in dollars per household to reduce wildfires in old-growth forests.

¹⁾The mean is the average, the quantity that is determined by dividing the sum of two or more quantities by the number of quantities added. The median is the number halfway between the smallest and the largest. For example, take the numbers 2, 5, 8, 26, 27, 30, and 50. The average is 21.14, and the median is 26.

Table 1. Average amount people are willing to pay to reduce the risk of wildfire in old growth forests.

	Amount People Are Willing To Pay Per Hectare	Amount per Acre (Multiply the per hectare amount by 2.47)
People in California	\$386	\$953.42
People in New England	\$128	\$316.16



Reflection Section

- Why do you think that people in California are willing to

pay more money to reduce fire risk in California and Oregon old-growth forests than people in New England?

- Look at table 1. From this table, can you tell how many hectares equal 1 acre? How many would you say that it is?

Implications

Using the amounts calculated from the responses to their questions, the scientists concluded that people in California and New England place a high value on protecting old-growth forests for northern spotted owl habitat. This study shows that old-growth forests are important for many reasons, including providing habitats for endangered species such as the northern spotted owl. In the future, people that make decisions about whether to pay for

a prescribed fire may want to consider many different kinds of values, including the value of providing habitat for endangered species.



Reflection Section

- Are you surprised that people in New England are

willing to pay money to protect owl habitat that is located across the country in California and Oregon? Why?

- Do you think that people that make decisions about using tax money for prescribed fires should consider values like providing habitat for endangered species? Why or why not?



FACTivity

In this FACTivity, you will answer the questions: What is the value of a

favorite possession? Is there just one value, or is the value different for different people? Why might different people place different values on an item? To answer these questions, you will follow this method: Select five classmates to bring a favorite personal possession to class. It could be something like a stuffed animal or a model car. For each of the five items, construct a survey using the form below as a guide. Make one copy of the survey for each member of the class. Each class member

Questionnaire Example for Each Item

I am a boy_____ girl_____	I Am Willing To Pay This Amount
Item 1:	
Item 2:	
Item 3:	
Item 4:	
Item 5:	

Example of Results: 15 Average Amounts

	Overall Average Amount	Girls' Average Amount	Boys' Average Amount
Item 1:			
Item 2:			
Item 3:			
Item 4:			
Item 5:			

will write in the maximum amount they would be willing to pay to purchase each item. Try to be realistic, as if you really had a chance to purchase the item (but you do not really have that chance!). A class member cannot submit an amount for their own item.

Collect all of the surveys and calculate the average amount the class is willing to pay for each item. To calculate the average, add all of the amounts and divide the total by the number of classmates participating in the bidding

for that item. Calculate the average amount that the girls are willing to pay for each item. Then, calculate the average amount that the boys are willing to pay for each item. You will have 15 average amounts, 3 amounts for each item. (See the example below.) Hold a discussion in your class on the average value of each item. Are the values different for boys and girls? Why do you think this is? Would the person that owns the item be willing to sell his or her item for the average amount?

Why or why not? As a class, discuss what this FACTivity illustrates about the value of an item. What are the similarities and differences between bidding on a classmate's favorite item and being willing to pay a certain amount to protect endangered species habitat?

From: Loomis, J. B. and González-Cabán (1997). Comparing the economic value of reducing fire risk to spotted owl habitat in California and Oregon. *Forest Science*, 43(4): 473-482.

Smoke and Mirrors:

Detecting the Amount of Gases in Wildland Fire Smoke



Glossary

ecosystem (e kō sis tem): Community of plant and animal species interacting with one another and with the non-living environment.

gaseous emissions (gash us e mish ens): Things discharged in the form of gas.

troposphere (trop uh sfer): The part of the atmosphere from Earth's surface up to about 6 miles.

vegetation (vej uh tā shun): Plant life.

molecules (môl uh kyools): Smallest particles of a substance. Consist of one or more atoms.

compounds (käm pownds): Chemical substances formed from two or more elements.

duct (dukt): A tube or a channel through which a gas or liquid moves.

plume (plūm): Something that is shaped like a large, fluffy feather.

sample (sam pul): Part or piece that shows what the whole group or thing is like.

simulated (sim yoo lat ed): Created the appearance or effect of something for purposes of evaluation.

upwind (up wind): The direction from which the wind is blowing.

Pronunciation Guide

a	as in ape	ô	as in for
ä	as in car	u	as in use
e	as in me	ü	as in fur
i	as in ice	oo	as in tool
o	as in go	ng	as in sing

Accented syllables are in bold.



Dr. Yokelson



Dr. Ward



Dr. Griffith



Dr. Susott



Dr. Babbitt



Dr. Wade



Dr. Bertschi with African teens



Dr. Hao

Meet Dr. Yokelson:

I like being a scientist because in my job as a scientist at least one interesting thing happens almost every day.

Meet Dr. Ward:

I like being a scientist because every day brings something new. Being a fire scientist is important. I study questions about the danger of fire smoke to human health, whether forest fires contribute to global warming, and how to use small fires to protect society from big fires. The answer to one question often leads to many other questions.

Meet Dr. Griffith:

I like being a scientist because I am curious about what makes the world around

me work the way it does. I enjoy developing instruments so that I can make careful measurements in our atmosphere. These measurements help me to solve problems. Being a scientist is a challenge, and it is very satisfying when you can help people solve problems.

Meet Dr. Susott:

I like being a scientist because I get to work in interesting places with other scientists on problems of worldwide importance.

Meet Dr. Babbitt:

I like being a fire scientist because big fires are almost always exciting.

Meet Dr. Wade:

I like being a scientist because I get to investigate wildland fire. Wildland fire is one of nature's most awesome forces. Through research I learn how it can be harnessed to improve ecosystem health.

Meet Dr. Bertschi:

I like being a scientist because doing research is fun. Sometimes I get to go to interesting places to discover new things about the environment. I also like to tell others what I have discovered, and we get to share and discuss our ideas.

Meet Dr. Hao:

I like being a scientist because I want to understand the impact of human activities on the global environment.



Thinking About Science

Scientists often work with other scientists on their research projects. This is similar to what you do when you work with other students on a class project. In this study, scientists from the University of Montana, the USDA Forest Service, and the University of Wollongong in Australia worked together to study the *gaseous emissions* of forest fires. What are the advantages of working with others when you are trying to learn something new? What are the disadvantages?



Thinking About the Environment

You have probably heard a lot about global warming. Global warming is the gradual warming of the Earth. Some scientists believe that it will take decades or more to prove that global warming is or is not occurring. Other scientists believe that there is enough evidence now to claim that global warming exists. Global warming occurs when too much heat is trapped in the *troposphere* by certain kinds of gases. These gases are commonly called greenhouse gases. Some warming of the troposphere is necessary because the Earth would freeze without it. When green-

house gases escape from Earth and are trapped in the troposphere, the heat is reflected back to Earth. One of the things that might cause greenhouse gases to escape into the troposphere is forest fires. The scientists in this study wanted to know the amount of greenhouse gases escaping to the troposphere during forest fires.

Introduction

Some kinds of forest fires can be beneficial to the natural environment and to people. Fire is a normal event in the natural environment. Some types of *vegetation* need fire to reproduce, and fire can help prepare the soil for new plant growth. Fires are sometimes purposely used by people to clear leftover trees and vegetation from an area after large trees have been cut for human use. Fires are also used to clear land of trees when the trees are not useful for lumber or other wood products. Forest fires also have some disadvantages. If they are not controlled, they might destroy homes and other buildings. Fire also produces gaseous emissions, some of which might contribute to global warming. The scientists in this study wanted to test the smoke that comes from forest fires to discover the amount of greenhouse gases going into the troposphere.



Reflection Section

- What is the question the scientists are trying to answer?
- If you were the scientist, how would you test the smoke coming from a forest fire?

Methods

The scientists built a special box to collect and measure the gases coming from forest fires. They put an instrument, called an infrared (*in fruh red*) spectrometer (*spek trôm uh tür*), into the box. An infrared spectrometer can identify what kind of *molecules* and *compounds* are in the smoke. It does this by shining infrared light into the smoke (figure 1). Different kinds of molecules react in different ways to the light. The spectrometer measures and records the reaction of the molecules and compounds, and from these measurements the scientists can identify the different kinds of molecules and compounds. They put the spectrometer in an airplane (figures 2 and 3).

To collect the smoke, they built a *duct* in the front of the plane, leading from the outside to the inside, and connected it to the spectrometer in the box. They also built a duct in the back of the plane, leading from the box to the outside. They put valves in the ducts so that they could control the air flow (figure 4). The scientists then flew the plane over three forest fires burning

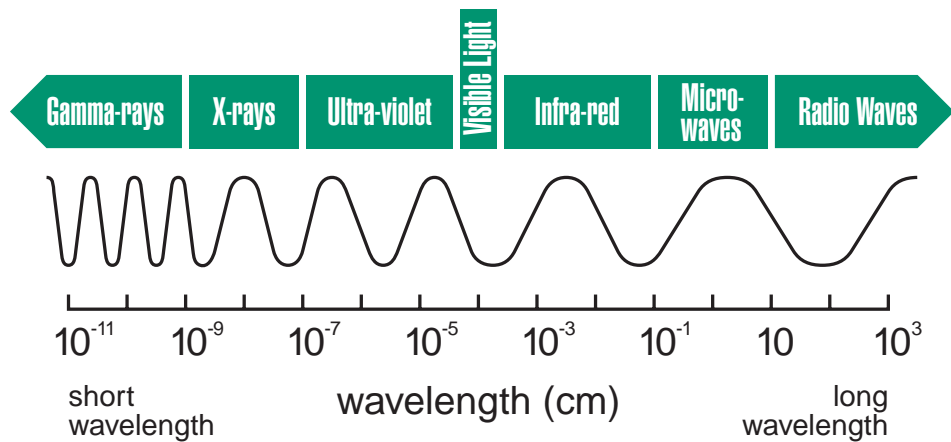

Figure 1. *Electromagnetic spectrum, showing the area of visible light and the light waves outside of the visible spectrum. Note the location of infrared light waves.*

in North Carolina (figure 5). The scientists collected smoke by opening the duct valves in both the front and back of the plane. Then they flew into the smoke *plume*. While they were in the smoke plume, they closed both of the valves (figure 6). In this way, the scientists collected *samples* of the smoke from the forest fire. The scientists flew the plane back and forth for many hours. They were able to collect many samples of the forest fire smoke.



Figure 2. *USDA Forest Service Air King 90. The smoke intake is visible in the side cockpit window. The pilot sat on the other side of the cockpit.*

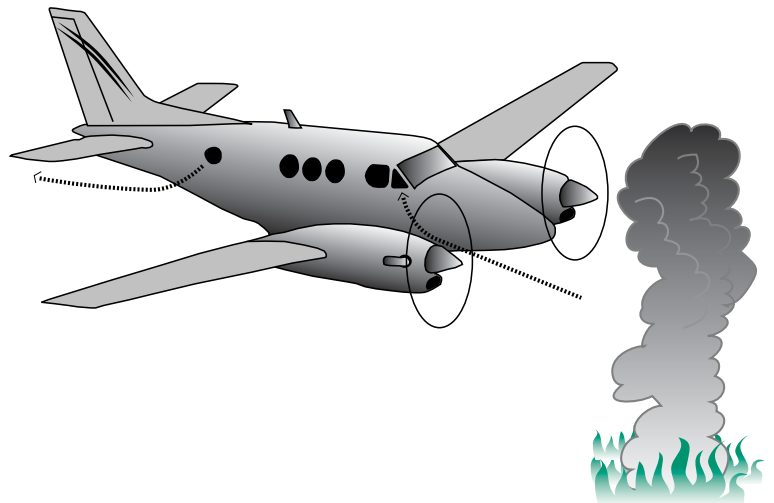

Figure 4. *Example of the duct system showing how forest fire smoke was moved through the spectrometer as the airplane flew through forest fire smoke.*

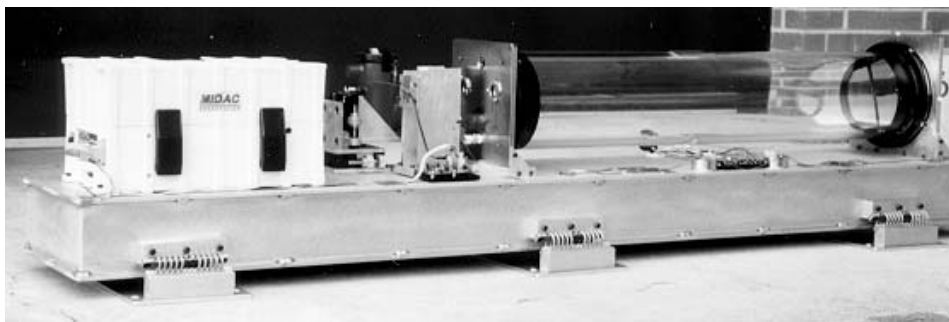

Figure 3. *The spectrometer before it was placed into the airplane.*

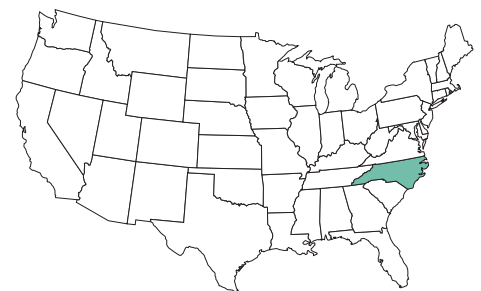

Figure 5. *North Carolina, on the east coast of the United States.*

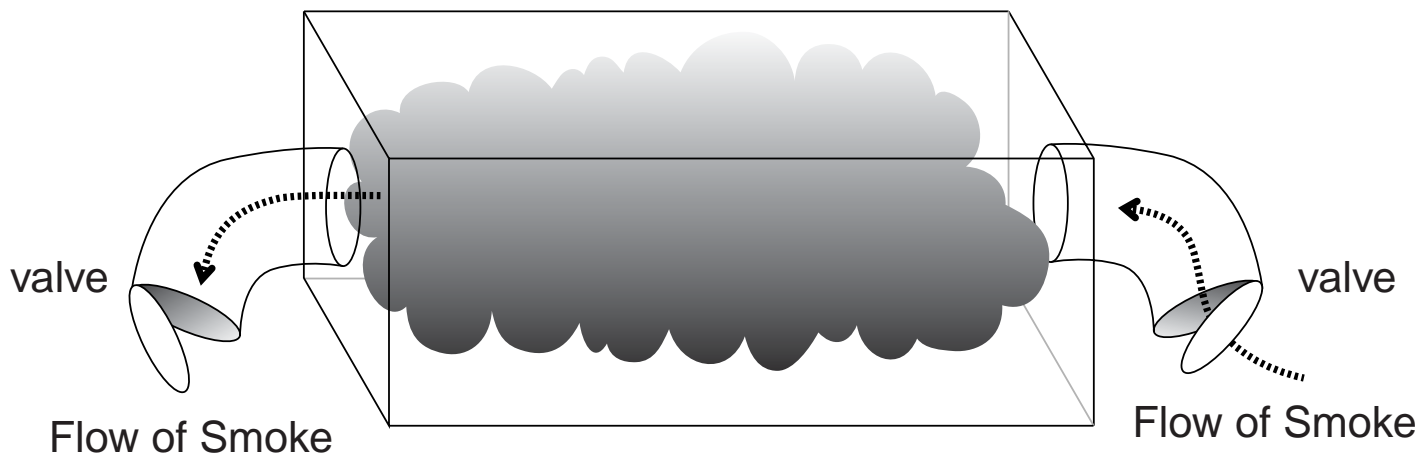

Figure 6. *The flow of the smoke was regulated by valves.*

The scientists used the spectrometer to measure the amount of certain greenhouse gases contained in the smoke. They measured formaldehyde (fôr mowl duh hid), acetic (uh set ik) acid, and methanol (meh than ôl). These three gases contribute to global warming by helping to create the greenhouse gas ozone (O₃). In the past, the scientists had *simulated* forest fire smoke in their laboratory. They had already measured the amount of these gases in the laboratory smoke as in the smoke from the actual forest fires. Then, they compared the

amount of gases in both kinds of smoke.



Reflection Section

- Why do you think it is important to know how much greenhouse gases are contained in the smoke from forest fires? (Hint: Where does the smoke from these fires go?)
- Why do you think that the scientists compared the laboratory smoke with the actual smoke from forest fires?

Results

The scientists found that the amounts of formaldehyde, acetic acid, and methanol from the forest fires were similar to the amounts of these gases found in the laboratory smoke. Then, the scientists took all of their measurements and compared them with the amount of these gases other scientists had found in other research studies. The scientists in this study found greater amounts of the three types of gases than other scientists had found.

Fire Facts

Fires need fuel, heat, and oxygen to begin burning and continue burning. Although air usually contains about 21 percent oxygen, fire requires air with only 16 percent oxy-

gen to burn. Wildland fire fuels are materials such as green plants, tree branches, and other burnable materials. When fuel burns, it reacts with the oxygen in the air, releasing heat and creating gases, smoke, and particles.

This process is known as oxidation (ox uh dă shun). Some of the gases created during oxidation may contribute to global warming. Close to Earth, the gases and particles in smoke can cause dangers to people's health.

Fire Safety Tips

Smoke from either wild-land fires or uncontrolled home fires is very dangerous. The smoke from these fires poses a serious risk to human health and safety. If there is a fire in your home and smoke is surrounding you, stay as close to the floor as possible as you leave the house. Do

not go toward the smoke, and use an escape route away from the smoke. Cover your nose and mouth with a damp cloth if possible. If you are outside near a wildfire or other fire, stay *upwind* of the fire, away from the smoke and the fire. Remember, smoke poses a serious danger to your health and safety – stay away from it!



Reflection Section

- Why do you think the scientists wanted to know how the

actual forest fire smoke compared with the smoke they created in the laboratory? What would be the advantage of being able to create smoke in the laboratory that is similar to actual forest fire smoke?

- Why do you think it is important to compare current research results with earlier research results?

Implications

When formaldehyde, acetic acid, and methanol combine with other gases in the troposphere, ozone is formed. Ozone increases the possibility of global warming (See “Thinking About the Environment,” above). Previous research had indicated that these three gases are

not present in large amounts in forest fire smoke. However, the scientists in this study found that there are larger amounts of these gases in smoke than scientists had thought before. If the results from future studies agree with these results, forest fires may be become known as another source of gases that contribute to global warming.



Reflection Section

- Do you think that more studies should be done on this topic? Why or why not?



FACTivity

In this FACTivity, each student will answer the question: What barriers might you face if you had to quickly escape from a fire in your

home? The method you will use to answer this question is: Each student will think about a fire occurring in the kitchen of their home. This is where many home fires start. When you learn about the fire, you are in your bedroom. What steps will you take to escape from your home? Get into groups of four students and discuss what you would do. Also discuss what you might do in advance of a fire, such as decide as a family where you will meet outside if a fire occurs, or where you should keep fire extinguishers in your home. As a class, make a list of the questions and barriers that you would face as you escape a fire in your home. Examples include whether to grab your favorite possession, or whether you would have to escape from a window. As a class, discuss the steps you would take. Develop five tips for escaping a fire and post them in your classroom.



Another FACTivity

The question you will answer with this FACTivity is:

How do mirrors

affect the distance light waves travel to reach an object? The method you will use to answer this question is: Get a shoe box, and two inexpensive mirrors, about 3.5 inches X 4 inches each. Tape the mirrors to one side of each end, as shown in the illustration below. Poke a small hole on one end where there is no mirror. On the other end, poke five holes. Turn the lights off so that the room is dark. Using a laser pointer (used for presentations), shine the pointer from the outside through the one hole. **WARNING:** Do NOT point the laser at any people! First, point the beam directly at one of the

five holes, trying to get the beam to shine through the hole. One of your classmates can hold a piece of black paper about 1 foot from the outside of the opposite hole to make it easier to see the beam. Now using the mirrors, try to get the beam to come out of each of the five holes. If you can get dry ice (ask at your grocery store), line the shoe box with aluminum foil. Place the dry ice in the bottom of the box and cover the box with a piece of clear plastic or plexiglass. The dry ice will enable you to see the beam inside of the shoe box.

WARNING: Have your teacher or an adult handle the dry ice.

Estimate how long the direct beam of light is between holes. You can use a ruler to measure the approximate distance. Now use the ruler to estimate how long the reflect-

ed beam is between holes. What happens to the length of the light beam when mirrors are used?

When using an infrared spectrometer, the infrared light causes molecules in the smoke to vibrate. The longer the beam of light, the better able scientists are to use the sample of smoke to identify chemicals. This is because a longer light beam will create more opportunity for vibration of the smoke molecules. This gives the scientists more information. The infrared spectrometer in this study caused the infrared light beam to travel back and forth 120 times! The spectrometer was only 0.8 meter long (to find out how many feet this is, multiply 0.8×3.28). How long was the light beam after it traveled back and forth 120 times? Now you know why the infrared spectrometer is built with mirrors.

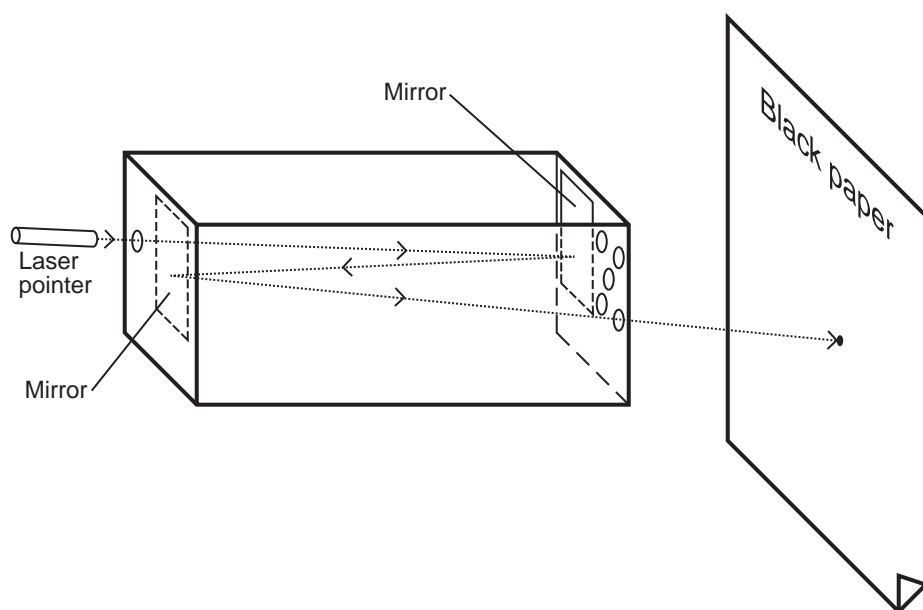

From Yokelson, R. J., Goode, J. G., Ward, D. E., Susott, R. A., Babbitt, R. E., Wade, D. D., Bertschi, D. W. T., and Hao, W. M. (1999). Emissions of formaldehyde, acetic acid, methanol, and other trace gases from biomass fires in North Carolina measured by airborne Fourier transform infrared spectroscopy. *Journal of Geophysical Research*, 104(D23): 30,109-30,125.

Liar, Liar, House on Fire!

The Relationship Between Trees, Wildland Fire, and Damage to Homes



Glossary

ignition (ig ni shun): The act of setting on fire or catching on fire.

forest managers (f6r est m6n ij 6rs): Skilled individuals that take care of natural resources.

endangered (en d6n j6rd): Legal term referring to a species whose existence is in danger.

decompose (de k6m poz): To rot or decay.

combustible (k6m bus tuh bul): Capable of catching fire and burning.

simulate (sim yoo lat): To create the appearance or effect of something for purposes of evaluation.

downwind (down wind): In the direction toward which the wind is blowing.

case studies (k6s stuh des): Particular events or stories used as a learning tool.

firebrands (fir brands): Burning embers that fly out of **intense** fires.

intense (in tens): Very strong or great.

nonflammable (non fl6m uh b6l): Not easily set on fire.

data (d6 tuh): Facts or figures studied in order to make a conclusion.

landscape plan (land scap plan): A drawn plan to make a piece of ground more attractive by adding trees, plants, shrubs, and flowers.

Pronunciation Guide

a	as in ape	6	as in for
6	as in car	u	as in use
e	as in me	6	as in fur
i	as in ice	oo	as in tool
o	as in go	ng	as in sing

Accented syllables are in **bold**.



Meet Jack Cohen:

I like being a scientist because I am curious about nature and I like to ask questions. It's great to have a job that pays me to find out how things happen. As a fire scientist, I can explore my lifelong interest in fire. I use my understanding of how fires burn to help solve problems with fire in wildlands. Solving problems with wildland fire helps people to find ways to live in harmony with fire.

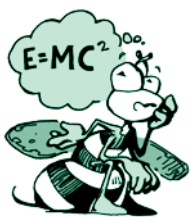

Thinking About Science

Scientists are like detectives because they solve mysteries. Like detectives,

scientists sometimes follow many different clues and determine if all of the clues lead them to the same conclusion. When a detective follows a clue, he or she plans in advance how that clue will be

followed. Scientists also develop plans to solve problems. Their plans are called methods. In this study, the scientist used three methods to find out under which conditions houses might catch fire from forest wildfires. Then the scientist compared the methods to see if all three of the methods (or clues) led him to the same conclusion. Can you think of a time when you do the same thing? Think about the latest movie hit. To determine if the movie is good, you might ask your friends if they liked the movie (clue #1); you might read about the movie in a magazine, newspaper, or on the Web (clue #2); and you might see the movie yourself (clue #3). When you do this, you are like a scientist!



Thinking About the Environment

Sometimes things happen in the environment that people call natural disasters. A natural disaster is a natural disturbance that people judge to be harmful. When injury or harm does not occur, these natural events are recognized as normal environmental events that happen at a large scale. Examples include floods, avalanches, and wildfires. Wildfires are different than floods and avalanches in one important way. Floods and avalanches consist of a mass, such as water or snow, which moves and completely covers everything in its path. Fire does not move in this

Fire Facts

For a fire to burn, it needs fuel, heat, and oxygen. When forest managers want to control forest fires, they try to reduce or eliminate the amount of fuel, heat, or oxygen that is feeding the fire. For a wildland fire, fuel consists of burnable material such as trees, shrubs, and grasses. Once a fire is burning, it continues to provide heat that supports the fire. Heat is transferred in three ways to nearby unburned

fuel. Two of these ways play an important role in the life of a wildland fire. Convection (kän vek shun) happens when heat is transferred through the flow of liquids or gases, such as when hot air rises above a fire. A fire can spread from the ground to shrubs and into treetops by convection. Radiation (rad e a shun) transfers heat by rays, such as from the sun or the flames of a fire. Radiation is the way most of the heat from a wildland fire is transferred to unburned fuel.

way. Fire spreads from the continual **ignition** and burning of fuel. For a fire to spread, it must have fuel, heat, and oxygen. If any one of these three is not present in a great enough amount, a fire cannot spread. Scientists call this the fire triangle.

Introduction

When lightning or other forms of ignition start a fire in a forest, there is a chance of a wildfire. Wildfires may be started by a natural cause, such as lightning, or they may be started accidentally by human activities or on purpose by an ill-meaning person. When wildfires are started by a natural cause, **forest managers** may let them burn if there is no threat of injury to people, to houses or other structures, or to **endangered** wildlife. In the past 10 years, however, wildfires have threatened, damaged, or destroyed hundreds of houses. One reason for this is that more and more houses are being built in what was once large areas of forests and shrubs.

When houses are built close to trees, the trees provide the fuel that wildfires need to spread. (Remember the fire triangle?) If trees and shrubs are close to a house, they can enable wildfires to burn close to the house. The question the scientist wanted to answer was: How close must flames come to a house's outside wooden walls before those walls catch fire?



Reflection Section

- Can you think of another way to ask the scientist's question? (Hint: Think about the trees' distance from the house.)
- If you were the scientist, what is one way that you might answer this question?

Method

The scientist collected information from three places to find the clues he needed to answer his question. First, the scientist used information from another scientist's research to create a computer program. The computer program predicted how much heat is needed before a wooden wall would catch fire. When wood gets hot enough, it begins to **decompose**. As wood decomposes, it releases **combustible** vapors into the air. The computer program helped the scientist to determine how close flames would have to come to a house to heat the wood hot enough so that it might be ignited by a little spark.

Second, the scientist set up an experiment. In his experiment, he built three wooden walls that were meant to **simulate** the walls of a house (figure 1). The walls were built in a field near a forest. The walls were built 10, 20, and 30 meters **downwind** of the forested area. (To determine number of feet, multiply the number of meters by 39.37



Figure 1. *One of the wood walls built by the scientist for his experiment.*

and divide by 12.) Into each of the three walls, the scientist placed an instrument that measured the amount of heat reaching the wall. The scientist then set fires in the forest to simulate a forest wildfire (figure 2).

Third, the scientist was concerned that the computer program and the experiment did not include all of the factors present during an actual wildfire. He went to the library and read about two other wildfires and how they destroyed houses. These **case studies** gave him actual stories of homes being destroyed by wildfire. The scientist was able to compare the case studies with the computer program and the experiment.



Reflection Section

- Think about each of the three ways that the scientist used to find clues to answer his question. Name a rea-



Figure 2. *The experimental fire.*

son why each way alone might not give the scientist the right answer.

- If each of these three ways that the scientist used gave him three very different answers to his question, do you think the scientist could draw a conclusion about how close trees must be to a house to set the house on fire? Why or why not?

Findings

The computer program taught the scientist that even very large wildfires will not cause wood structures to ignite if the fire is farther than 40 meters away. (How many

feet is that?) The farther a source of flame is from wood, the less heat the wood receives (figure 3).

In the scientist's experiment, flames never swept very far beyond 10 meters from the forested area. When the flames got close to—but did not make contact with—the wall built 10 meters away from the forested area, the wall was scorched but did not ignite (figure 4). When the flames made contact with this wall, it ignited and began to burn. When the flames extended just beyond 10 meters, the wall built 20 meters away was only lightly

scorched but did not ignite. The wall built 30 meters away was not scorched at all and did not ignite. The scientist found that *firebrands* contribute to the ignition of wooden walls during wildfires.

By reading the case studies, the scientist learned that between 86 percent and 95 percent of the houses with a *nonflammable* roof and trees no closer than 10 to 18 meters (How many feet is that?) survived the wildfires (figure 5).

When the scientist compared the amount of heat predicted by the computer program for a distance of 10 meters with his experimental *data*, he found that the program predicted greater heating than he actually found.

However, the scientist found that all three ways of determining ignition distances generally agreed. When trees, which serve as fuel for a wildfire, are between 10 and 40 meters away from a wooden structure, even intense wildfires will not ignite the structure 90 percent of the time.



Reflection Section

- The scientist's experiment showed that walls located 20

meters away from flames will not usually ignite in a wildfire. The computer program predicted that trees burning 40 meters away will not ignite a structure. The case studies mentioned

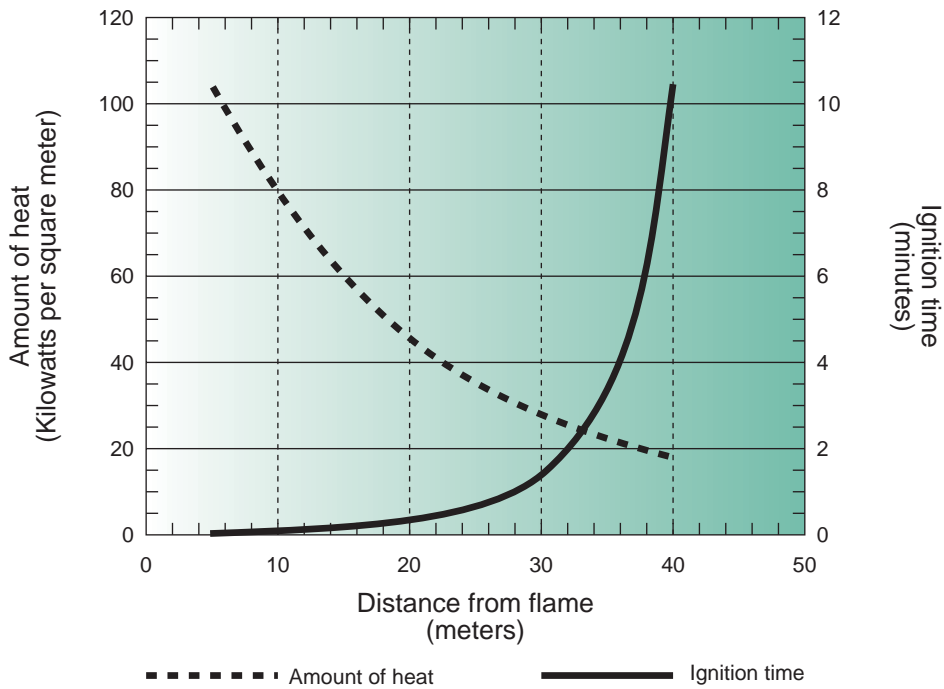

Figure 3. The relationship between the amount of heat, ignition time, and distance from the flame.

The scientist concluded that people who own houses should take responsibility for making their houses safe from wildfires.



Reflection Section

- Do you think that people should take responsibility for making their houses safe from wildfires? Why or why not?
- Based on this research, how could people make their houses safer from wildfires?



Discovery FACTivity

The problem you will solve with this FACTivity is: What are the potential wildfire problems with a particular home's *landscape plan*? How can you change the landscape plan to make the home safer from wildfires? The method you will use to solve this problem is: Look at the landscape plan on the next page. This plan is drawn from a bird's eye view. Using a ruler, you will need to determine which trees and other vegetation are too close to the house to protect it from wildfires. You can determine this distance from reading the "Findings" section of the article above. The symbols for the house, trees, shrubs, and the driveway are shown. Then, get a blank piece of paper, 8 inches X 11 inches or larger. Using your

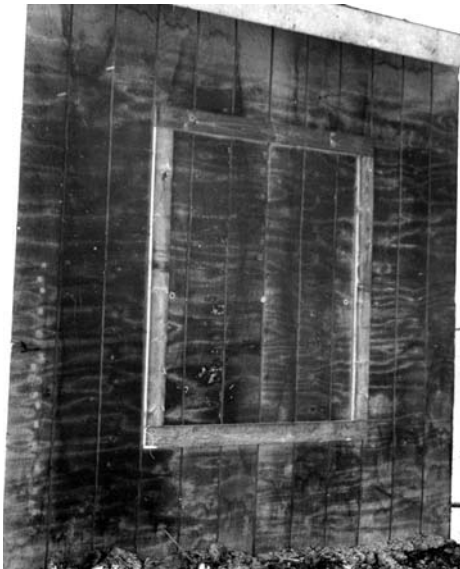

Figure 4. When flames did not make contact, the wall built 10 meters away was scorched but did not ignite.

a distance of 10 meters. Why do you think the scientist used a range of 10 to 40 meters when reporting his results?

- If you were the scientist, what would you recommend as a result of this research?

Implications

The scientist reported that the condition of the house and its surroundings, within 40 meters, are responsible for the house catching fire during intense wildfires. The area of land around a house is usually owned by the homeowner.



Figure 5. Almost 9 out of 10 houses that were at least 18 meters away survived a wildfire.

ruler and a pencil, develop a landscape plan that places trees, shrubs, and other vegetation close to the house, but not so close as to cause a danger from wildfires. To do both of these tasks, you will need to convert the measurement of meters to inches using your ruler. For your own landscape plan, 1 inch equals 20 meters. Compare your landscape plan with your classmates'. Discuss why you designed the home's landscape the way that you did, and how your landscape plan will help to protect the home from wildfires but still provide the benefits of trees and other vegetation.

From: Cohen, J. D. (2000). Preventing disaster: Home ignitability in the wildland-urban interface. *Journal of Forestry*, March 15-21.

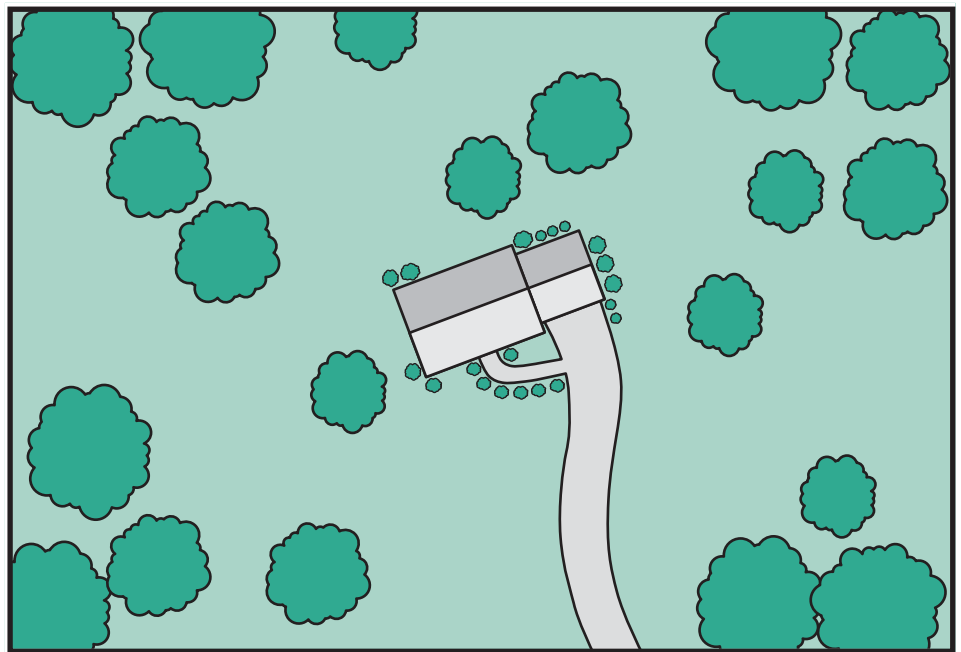

Legend:

-  Large Tree
-  Bushes

Scale:

1/2" = 20 meters

For your landscape plan, use this scale:
1 inch equals 20 meters.

Fire Safety Tips from the Firewise Communities Program

Do you live in or near a forest? If so, ask the adults in your household if they have protected the house from a forest fire. Here are some things you can do to protect your house from fire:

1. Establish a space around your house that does not have any combustible materials. This space should be at least 30 feet or 9 meters across. The larger the space, up to 130 feet or 40 meters, the better protected your house will be.

2. Reduce the amount of vegetation close to your home.

3. Remove or thin overcrowded or weak trees near your home.

4. Cut your grass and other plants regularly.

5. Move wood piles and building materials away from your home.

6. Keep your roof and yard clean. Clean your gutters regularly. Remove dead limbs and branches from your yard, and from the base of your chimney and deck.

7. Make sure your address is easy to read from the road, and that your driveway is large enough for emergency vehicles.

8. If you have a wood shake roof, replace it with a material that is more fire resistant.

9. Recycle your yard waste.

10. Listen to your local radio and TV stations for fire reports and instructions.

Dew It!

Which Weather Measurements Are Related to the Occurrence of Wildland Fire?



Glossary

complexity (käm plek suh tē): The state of being complicated or having many related parts.

predict (pre dikt): To tell what one thinks will happen in the future.

wildfire (wild fir): An uncontrolled wildland fire started naturally or by careless human action.

associated (uh sō she a ted): Closely connected with another.

relative humidity (rel uh tiv hū mid uh te): The percentage of water vapor in the air relative to the total amount of water vapor the air can hold at that temperature.

weather stations (weh thür stā shuns): Places where instruments measure and record weather conditions.

saturated (sah chür at ed): Soaked completely through.

intensity (in ten si tē): The quality of being very strong.

Pronunciation Guide

a	as in ape	ô	as in for
ä	as in car	ü	as in use
e	as in me	ü	as in fur
i	as in ice	oo	as in tool
o	as in go	ng	as in sing

Accented syllables are in bold.



Meet Dr. Potter:

I like being a scientist because as a child I never stopped asking why. As an adult, I'm still asking why.



Thinking About Science

The world is a complicated place. When you look closely at things in nature, you will find that many things are connected in one way or another. Scientists study this *complexity* in nature, but they also search for simpler ways to understand what they observe.

One of the ways that they try to simplify their research is by studying things piece by piece. Instead of observing everything all at once, they observe and measure separate things. Then, they examine how the separate things are related. In this study, the scientist wanted to know which daily weather conditions are most related to forest wildfires. To answer his question, he divided the daily weather

conditions into separate measurements. The daily weather is not really a lot of separate conditions. Instead, it is a related set of conditions. However, by separating the weather into different kinds of measurements, the scientist made the problem easier to study and to understand.



Thinking About the Environment

Wildfires can be a threat to the health and safety of people and animals (figure 1). Wildfires might be started by mistake, as when people are not careful with campfires or with matches. Wildfires may also be started by lightning or by other natural means during dry weather. Most people know that weeks of dry weather will increase the danger of a wildfire. Whether a wildfire spreads may also depend on the weather that occurs each day. If the weather on some days is more likely to help a wildfire to spread, people should be extra careful with matches or

with fire during those days. The scientist in this study wanted to identify the most important daily weather conditions that were *associated* with a dangerous or a large wildfire. To identify these conditions, the scientist measured things like air temperature, *relative humidity*, and wind speed.

Introduction

Although scientists know that many weeks of low rainfall increase the chances of wildfires, they do not know which daily weather conditions are the best for determining the danger of fire. Scientists believe that when certain kinds of weather conditions occur, they can better predict wildfires.

Unfortunately, they have not checked to see if these same conditions occur on days with no wildfires. If scientists can determine which daily weather conditions are the best for identifying the risk of wildfires, they can more easily determine which days wildfires might occur. The scientist in this study wanted to determine which daily

weather conditions are associated with large or dangerous wildfires.



Figure 1. *Wildfire.*



Reflection Section

- What is the question the scientist is trying to answer?
- Is it important to be able to predict on which days a wildfire might burn? Why or why not?

Methods

The scientist collected information from large wildfires that had burned in areas across the United States. To make sure that he was collecting weather information only for large wildfires, the scientist decided that wildfires burning less than 400 hectares would not be included. (To find out how many acres this is, multiply 400 times 2.47.) He found information on 459 large wildfires that had burned between 1971 and 1984 (figure 2).

The scientist collected weather measurements recorded at 20 *weather stations* on the dates the fires had burned (figure 3). For each wildfire, he used information from the closest weather station. He then divided the weather information from each weather station into four groups, based on the season the fire had burned. This meant that the scientist had information from each weather station for the days that wildfires burned in the spring, summer, fall, and winter (figure 4). The scientist also collected weather measurements for days in which wildfires had not burned. In this way, the scientist was able to compare the weather measurements made on days when wildfires did not burn with measurements made on days in which wildfires had burned.



Figure 3. *Weather station.*

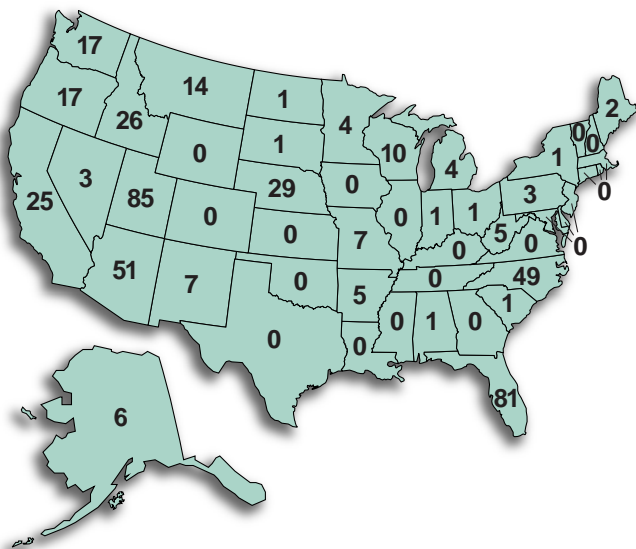

Figure 2. *Number of wildfires in each State.*

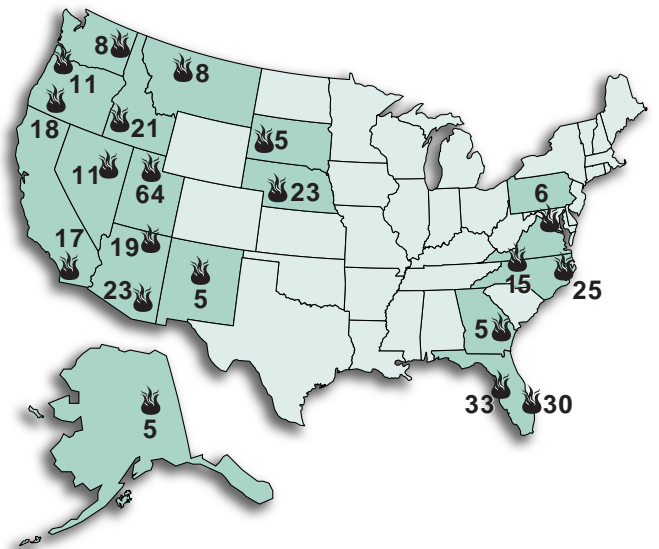

Figure 4. *Location of weather stations and number of days there were fires recorded at each weather station.*

Weather measurements used include air temperature, wind speed, relative humidity, dew point depression, and wind shear. Dew point depression is the air temperature minus the dew point temperature. The dew point temperature is the air temperature at which the air is *saturated* with water. Wind shear occurs when winds at different heights blow in different directions or at different speeds.



Reflection Section

- Why do you think that the scientist had to use weather

data from fires that had already occurred?

- Which of the five measurements do you think were more closely associated with large wildfires? Why?

Findings

The scientist found that air temperature, relative humidity, and dew point depression were the three weather measurements most associated with wildfires. When air temperature is high and the amount of water in the air is low, large or dangerous wildfires are more likely to burn. Of these three measurements, dew point depression is the single best measurement to use when trying to predict wildfires. When dew point depression is low, there is a lot of water in the air, and wildfires are not as likely to burn. When dew point depression is

Fire Facts

For wildland fires, fuels consist of burnable materials, such as trees, shrubs, and grasses. Besides the availability of fuel, the type of weather occurring at that time can help a wildfire spread. Air temperature, humidity, and wind affect the spread of a wildfire. A wildfire can gener-

ate its own wind, thus helping to spread itself. When the air above a flame gets heated, it rises. When it rises, fresh air rushes in to fill the vacuum. The fresh air provides a new source of oxygen for the fire. Thus, if fuels are available and there is a lack of moisture in the air, a wildfire can continue to spread in part by creating its own wind.

high, there is little moisture in the air and a wildfire is more likely to become large or dangerous.



Reflection Section

- Even without weather instruments, humans can generally

tell when the dew point depression is low. Even though you will perspire if the temperature is high, what happens to your perspiration when the dew point depression is low?

- Why do you think that your perspiration does not evaporate off of your skin when the dew point depression is low?

Implications

In the past, scientists thought that air temperature,

relative humidity, dew point depression, and wind shear were the weather measurements most associated with large or dangerous wildfires. This research suggests that dew point depression is the most important measurement. On days when large wildfires burned between 1971 and 1984, the dew point depression was high. When people try to predict wildfires based on weather conditions, they should pay the closest attention to dew point depression.



Reflection Section

- How did this research simplify what was known about

the association between wildfires and daily weather conditions?

Fire Safety Tips from Smokey and His Friends at the Texas Forest Service!

The Keetch-Byram (kech bi rum) Drought Index, or KBDI, is a mathematical system developed to help people understand how likely a wildfire is to occur. The KBDI rates current and expected weather conditions and places them on a numbered scale, from 0 to 800. Here are what the numbers mean:

1. 0-200: Soil and fuel moisture content are high. Most fuels will not readily ignite. There is not much danger of wildfire.

2. 200-400: Fires will more readily burn, but heavier fuels will not ignite readily.

3. 400-600: Fires will readily burn in all directions. In some places, all of the fuel on the ground will burn away. Larger fuels may smolder for many days, possibly creating problems with smoke.

4. 600-800: Fires will burn all of the fuels off of the ground. Fires will burn throughout the night and heavier fuels will actively burn, increasing the intensity of the fire.



Discovery FACTivity

The best time to do this FACTivity is when the temperature is high. It is best if the temperature is over 85 °F (or 29 °C). In this FACTivity, you will determine the air's dew point temperature. Dew point is the point at which the air, at a given temperature, can hold no more moisture. The question you will answer is: What happens when the air can hold no more moisture? For this activity, you will need a cleaned-out vegetable can, filled three-quarters high with water, a thermometer, a spoon, ice, paper, and a pencil. The method you will use to answer this question is: Let the vegetable can filled with water sit for a few hours outside in the shade. It should reach air temperature before you continue. Using the thermometer, measure the air tem-

perature in the shade and record the air temperature. Hold the thermometer against the outside of the can so you can measure the temperature of the air immediately outside of the can. Put some ice into the water and stir. The dew point of the air surrounding the can is the temperature registered on the thermometer when the first sign of moisture appears on the outside surface of the can. Record the temperature at dew point. What has happened? The ice has caused the air immediately surrounding the can to cool. As the air cools, it absorbs moisture which you cannot see until it can hold no more moisture. Now calculate the dew point depression. (See "Methods" to learn how to do this.) If the air temperature and the dew point are far apart, the air is dry and the relative humidity

is low. Weather reports often give the air's dew point temperature. Knowing the dew point will help you to determine whether dew or fog is likely to occur.

Activity from: Bosak, S. V. (2000). *Science is...: A source book of fascinating facts, projects, and activities*, Ontario, Canada: Scholastic Canada, Ltd., p. 446.

From Potter, Brian E. (1996). Atmospheric properties associated with large wildfires. *International Journal of Wildland Fire*, 6(2): 71-76.

TEACHERS, PLEASE COPY THIS FORM BEFORE DISTRIBUTING.

**STUDENTS,
Tell Us What You Think About *The Natural Inquirer***

1. The article I read was entitled:

- Let's Clear the Air
- Fighting Fire With Fire
- Time Will Tell
- Who Gives a Hoot?
- Smoke and Mirrors
- Liar! Liar! House on Fire!
- Dew It!

Circle the answer that best describes how you feel about the article you just read.

2. The article was:

- Easy to understand
- Hard to understand
- Very hard to understand

3. The article was:

- Very interesting to read
- Somewhat interesting to read
- Not interesting to read

4. Did you learn something from reading the article? Yes No

5. Did you try to answer the Reflection Questions?

- Yes No Some of them

If you read and tried to answer any of the reflection questions, did they help you to think about the article? Yes No

6. Would you like to read another article?

- Yes No

7. How old are you? (*Circle*)

9 10 11 12 13 other age: _____

8. What grade are you in? (*Circle*)

4th 5th 6th 7th 8th 9th

9. Are you a girl or a boy?

- Girl Boy

Now write in your answer:

10. What did you learn from reading the article?

11. What is your favorite subject in school?

*Along with your class or by yourself,
please send this form to:*

Dr. Barbara McDonald
USDA Forest Service
320 Green St.
Athens, GA 30602-2044

Thank you!

PLEASE COPY THIS FORM BEFORE COMPLETING.

The Natural Inquirer—Teacher Evaluation

For each article that you read, please answer the following:

Name of Article: _____

1. Would this article help you meet any of the required statewide science curriculum standards? Yes No

2. How close to the appropriate reading and comprehension level for your students is this article written?

- Very close
- Somewhat close
- Not close

3. If the article is somewhat close or not close to the appropriate reading and comprehension level, is it:

- Too hard
- Too easy

4. Would or did you use this article in your classroom as an educational resource?

- Yes No Why or why not?

5. Please rate the article sections on a scale of 1 to 5. One means the section was not useful at all, five means the section was very useful.

	Not useful			Very useful	
Sidebars	1	2	3	4	5
Glossary	1	2	3	4	5
Introduction	1	2	3	4	5
Methods	1	2	3	4	5
Findings	1	2	3	4	5
Graphs, figures, photos	1	2	3	4	5
Reflection Questions	1	2	3	4	5
FACTivity	1	2	3	4	5

6. For any of the sections you rated with either a “one” or a “two” in question 5, please indicate why the section was not useful or how it can be improved:

Sidebars

Glossary

Introduction

Methods

PLEASE CONTINUE THIS EVALUATION ON THE NEXT PAGE 

Visit these Web sites for more information:

USDA Forest Service: www.fs.fed.us

The Natural Inquirer: www.naturalinquirer.usda.gov

USDA Forest Service Conservation Education: www.fs.fed.us/outdoors/nrce/

USDA Kid's Page: www.usda.gov/news/usdakids/index.html

Smokey Bear: www.smokeybear.com

Agriculture in the Classroom: www.agclassroom.org

Yellowstone National Park Wildfire:
www.discovery.com/stories/nature/yellowstone/yellowstone.html

Fire prevention tips for homeowners: www.firewise.org

Learn more about wildland fire: www.pbs.org/wgbh/nova/fire/ *and*
www.pbs.org/wgbh/nova/fire/simulation.html

To view a photo gallery of wildland fire: www.wildlandfire.com

National Interagency Fire Center: www.nifc.gov/

U.S. Fire Administration Kid's Page: www.usfa.fema.gov/kids/

Arkansas Fire Prevention tips: www.arkfireprevention.org/firesafetips.html

NatureWatch: www.fs.fed.us/outdoors/naturewatch/default.htm

National Forest Recreation: www.fs.fed.us/recreation

National Forest Information: www.fs.fed.us/recreation/map/finder.shtml

Which National Science Education Standards Can Be Addressed by *The Natural Inquirer*?

Standards	LET'S CLEAR THE AIR	FIGHTING FIRE WITH FIRE	TIME WILL TELL	WHO GIVES A HOOT?	SMOKE AND MIRRORS	LIAR! LIAR! HOUSE ON FIRE	DEW IT!
Science as inquiry							
Abilities Necessary To Do Scientific Inquiry	X	X	X	X	X	X	X
Understandings About Scientific Inquiry	X	X	X	X	X	X	X
Physical Science							
Properties and Changes in Properties Matter	X				X		X
Motions and Forces						X	
Transfer of Energy					X	X	
Life Science							
Structure and Functions in Living Systems		X	X	X			
Reproduction and Heredity		X					
Regulation and Behavior		X		X			
Populations and Ecosystems		X	X	X			
Diversity and Adaptations of Organisms			X	X			
Earth and Space Science							
Structure of Earth System							X
Science and Technology							
Understandings About Science and Technology	X				X		
Science in Personal and Social Perspectives							
Personal Health	X					X	
Populations, Resources, and Environments				X			
Natural Hazards	X	X	X		X	X	X
Risks and Benefits	X	X		X	X	X	X
Science and Technology in Society	X	X		X	X	X	X
History and Nature							
Science as a Human Endeavor	X	X	X	X	X	X	X
Nature of Science	X	X	X	X	X	X	X

What is the USDA Forest Service?

The USDA Forest Service is a part of the United States Department of Agriculture. It is made up of thousands of people who care for the Nation's forest land. The USDA Forest Service manages over 150 national forests and almost 20 national grasslands. These are large areas of trees, streams, and grasslands. National forests are similar in

some ways to national parks. Both national forests and national parks provide clean water, homes for animals that live in the wild, and places for people to do fun things in the outdoors. National forests also provide resources for people to use, such as trees for lumber, minerals, and plants used for medicines. Some people in the USDA Forest

Service are scientists, whose work is presented in this journal. USDA Forest Service scientists work to solve problems and provide new information about natural resources so that we can make sure our natural environment is healthy, now and into the future.



What is Agriculture in the Classroom?

Agriculture in the Classroom is a grassroots program coordinated by the USDA's Cooperative State Research, Education, and Extension Service (CSREES). The goal of Agriculture in the Classroom is to help students and teachers gain a greater awareness of the role of agriculture in the economy and in society. The

program is carried out in each State, according to State needs and interests. People involved at the State level represent farm organizations, agricultural businesses, education, and government.

The mission of the CSREES is to advance knowledge for agriculture, the environment, human health and well being,

and communities. The CSREES provides leadership to identify, develop, and manage programs to support university-based and other institutional research, education, and extension.



Agriculture in the Classroom

What is the National Interagency Fire Center?

As you know, when wildland fires burn they often cross property lines. One large wildfire may burn areas owned by different people or lands managed by different government agencies. When that happens, it pays for people to work together to control the fire. The National Interagency Fire Center is a partnership that works together on wildland fire. The

center's mission is to reduce the risks and losses to communities and the environment from wildland fires. The government agencies that work together include the following Department of Interior agencies: Bureau of Land Management, Bureau of Indian Affairs, National Park Service, and the U.S. Fish and Wildlife Service. The USDA Forest Service, the National

Association of State Foresters, the National Weather Service, and the Office of Aircraft Services are also part of this partnership. By working together, the National Interagency Fire Center can do a better job of protecting human communities and the natural environment from the risks of wildland fires.

